

Copyright 1997, 1999 - Remote Processing Corporation.
All rights reserved. However, any part of this document
may be reproduced with Remote Processing cited as the
source.

The contents of this manual and the specifications herein
may change without notice.

TRADEMARKS

RPBASIC-52™ is a trademark of Remote Processing
Corporation.

PC SmartLINK® is a trademark of Octagon Systems
Corporation.

BASIC-52© is a trademark of Intel Corporation.

Remote Processing Corporation
7975 E. Harvard Ave.
Denver, Co 80231 USA
Tel: (303) 690 - 1588
Fax: (303) 690 - 1875
www.rp3.com

NOTICE TO USER

The information contained in this manual is believed
correct. However, Remote Processing assumes no
responsibility for any of the circuits described herein,
conveys no license under any patent or other right, and
make no representations that the circuits are free from
patent infringement. Remote Processing makes no
representation or warranty that such applications will be
suitable for the use specified without further testing or
modification. The user must make the final
determination as to fitness for a particular use.

Remote Processing Corporation's general policy does not
recommend the use of its products in life support
applications where the failure or malfunction of a
component may directly threaten life or injury. It is a
Condition of Sale that the user of Remote Processing
products in life support applications assumes all the risk
of such use and indemnifies Remote Processing against
all damages.

P/N 1366
Revision: 2.8

TABLE OF CONTENTS

SECTION 1 OVERVIEW		SECTION 6 DIGITAL AND OPTO PORTS	
DESCRIPTION	1-1	INTRODUCTION	6-1
MANUAL ORGANIZATION	1-1	DIGITAL I/O PORTS	6-1
MANUAL CONVENTIONS	1-1	Digital Port J3	6-1
Symbols and Terminology	1-2	Digital Port P6	6-2
TECHNICAL SUPPORT	1-2	High Current Port L8	6-2
		Optically Isolated Input	6-2
SECTION 2 SETUP AND OPERATION		Digital I/O Commands	6-2
INTRODUCTION	2-1	High Current Output	6-3
OPERATING PRECAUTIONS	2-1	Interfacing Digital I/O to an opto-module	
EQUIPMENT	2-1	rack	6-4
FIRST TIME OPERATION	2-2	Interfacing to switches and other devices	6-4
Using a PC	2-2	Digital I/O programming example	6-4
Using a Terminal	2-2	Pulse Width Modulation (PWM)	6-5
UPLOADING AND DOWNLOADING		COMMANDS	6-6
PROGRAMS	2-2		
Editing programs and programming hints	2-3	SECTION 7 CALENDAR/CLOCK	
WHERE TO GO FROM HERE	2-4	DESCRIPTION	7-1
TROUBLESHOOTING	2-4	SETTING DATE AND TIME	7-1
		COMMANDS	7-1
SECTION 3 SAVING PROGRAMS			
INTRODUCTION	3-1	SECTION 8 DISPLAY PORT	
SAVING A PROGRAM	3-1	INTRODUCTION	8-1
AUTORUNNING	3-2	CONNECTING DISPLAYS	8-1
PREVENTING AUTORUN	3-2	WRITING TO THE DISPLAY	8-1
LOADING A PROGRAM	3-2	PROGRAMMING EXAMPLE	8-1
CHANGING EPROM SIZE	3-2	DISPLAY TYPES	8-2
ALTERNATE EPROMS	3-3	DISPLAY CONNECTOR PIN OUT	8-2
COMMANDS	3-3	COMMANDS	8-2
SECTION 4 SERIAL PORTS		SECTION 9 KEYPAD PORT	
DESCRIPTION	4-1	INTRODUCTION	9-1
COM0 SERIAL PORT	4-1	PROGRAMMING EXAMPLE	9-1
COM1 SERIAL PORT	4-1	KEYPAD PORT PIN OUT - J5	9-2
RS-422/485 OPERATING INFORMATION	4-2		
RS-422/485 Termination network	4-2	SECTION 10 ANALOG INPUT	
Two wire RS-485	4-3	DESCRIPTION	10-1
Multidrop Network	4-3	CONNECTING ANALOG INPUTS	10-1
ACCESSING SERIAL BUFFERS	4-3	Overvoltage conditions	10-1
ACCESSING COM0 AND COM1	4-4	Grounding	10-1
DISABLING CONTROL-C	4-4	INITIALIZATION	10-1
SERIAL PORT PIN OUT	4-4	Differential Mode	10-2
		Examples using CONFIG AIN	10-2
SECTION 5 RAM MEMORY		Acquiring Analog Data	10-2
INTRODUCTION	5-1	Noise Notes	10-3
CHANGING MEMORY	5-1	Temperature Measurement	10-3
BATTERY BACKUP	5-1	Data logging on a timer tick	10-4
Checking the battery	5-1	MEASURING HIGHER VOLTAGES	10-4
RESERVED MEMORY	5-2	CONVERTING ANALOG MEASUREMENTS	10-4
STORING VARIABLES IN RAM	5-2	Measuring 4-20 mA current loops	10-4
BLOCK DATA TRANSFER	5-3	AMPLIFIERS	10-5
ASSEMBLY LANGUAGE INTERFACE	5-3	CALIBRATION	10-5
COMMANDS	5-3	COMMANDS	10-5

TABLE OF CONTENTS

SECTION 11	WATCHDOG TIMER	
	DESCRIPTION	11-1
	EXTERNAL RESET	11-1
	DESCRIPTION	11-1
	OPTICALLY ISOLATED INTERRUPT . . .	11-1
	INTERRUPT CHARACTERISTICS	11-1
SECTION 12	EXTERNAL INTERRUPT	
	DESCRIPTION	12-1
	PROGRAMMING	12-1
	Program examples	12-1
	COMMANDS	12-2
SECTION 13	MULTI-MODE COUNTER	
	DESCRIPTION	13-1
SECTION 14	POWER REDUCTION	
	FURTHER POWER REDUCTION	14-1
	Program Example	14-2
SECTION 15	TECHNICAL INFORMATION	
	ELECTRICAL SPECIFICATIONS	15-1
	MEMORY AND I/O BANK MAP	15-2
	MECHANICAL SPECIFICATIONS	15-2
	JUMPER DESCRIPTIONS	15-2

SOFTWARE REVISION HISTORY

- V1.04 Release for RPC 320
- V1.05 BSAVE returned a hardware error when verify was bad. In fact, save was OK.
- V1.06 LCD graphics hardware CS and reset are reversed. Compensated in software.
- V1.07 MTOP was useless in any system, especially a 32K RAM.
- V1.08 Variables E and F would get dropped if followed by a space.
Added delays between data strobe writes to LCD display.
- V1.09 STR(7, . . .) did not put in a CR into the put string, causing longer strings to be printed.
- V1.10 Initial release for RPC-330.
Added AOT command (330 only)
Added COUNT, ON COM, ON COUNT, ON LINE, and ON KEYPAD
- V1.11 11/29/95
Added day of week to DATE command and function.
- V1.12 12/01/95
Added code to use Atmel 29C040A flash.
- V1.13 01/12/96
Added code to support IEE centry series display (3602-100-05420)
Includes PRINT #*port*
- V1.14 03/28/96
Fixed bug in ON COUNT. Returns error for lines > 100.
- V1.15 06/26/96
PEEK\$ could cause BASIC to lock up under right conditions.
- V1.16 02/18/97
ON LINE OFF could cause program to lock up if running ON COM.
Syntax error when DISPLAY used with IF-THEN-ELSE.
Added PEEKF and POKEF commands.

DESCRIPTION

The RPC-320 is an embedded controller with a built in Basic language. Several features make it suitable as a stand alone unit:

Built in RPBASIC-52 programming language supports hardware using single commands. On card flash EPROM programmer can save up to 8 programs to 62K, or about 500K total.

High speed multimode counter accepts quadrature or single inputs. Programmable for up/down, binary, divide-by-N, X1, X2 or X4 quadrature counting.

LCD character and graphic display and keypad ports for operator interface.

Two RS-232 serial ports, one of which is configurable for RS-422/485.

Watchdog timer resets card if a program "crashes".

34 digital I/O lines, 9 of which are high current outputs. 24 of these lines can connect to an opto rack or other TTL devices.

Eight channel, 12 bit resolution analog to digital converter. Configurable operational amplifiers allow you to signal condition inputs or measure temperature.

32K, 128K, or 512K RAM battery backable to save process variables and other data when power is off.

32K or 512K flash EPROM to save programs and data.

The RPC-320 uses an 80C320 CPU operating at 22.1184 Mhz. It can operate stand alone or on a network using the RS-485 port. Its 4.7" x 7.0" size with 4 mounting holes makes it easy to mount in a NEMA box. Compactness is enhanced by on-board analog and digital terminal strips.

RPBASIC-52 programming language is standard. This language is a version of the original Intel BASIC-52. It was modified for the RPC-320 for control, data acquisition applications, and on board hardware features.

Program development can take place on your PC, using your word processor, or on the RPC-320. Programs

from your PC are downloaded using a serial communication program.

MANUAL ORGANIZATION

This manual provides all the information required to install, configure, and operate the RPC-320. Using this manual you will be able to:

Interface the RPC-320 to your IBM compatible PC or terminal.

Understand the operation of the RPC-320 hardware using RPBASIC-52 programming software.

This manual assumes you are familiar with some type of BASIC programming software. The syntax used by RPBASIC-52 is similar to BASIC-52. If you are not experienced with any BASIC software, you may want to refer to books and training programs available through your local book store. The *BASIC-52 Programming Manual* has information and examples for the original commands. Commands unique or modified by RPBASIC-52 are in the Software Supplement in this manual.

Each chapter or section is written to first provide an overview. Then, more specific information is provided. Each chapter has some examples using Basic. A summary of related hardware commands is at the end of most chapters.

MANUAL CONVENTIONS

Information appearing on your screen is shown in a different type.

Example:

```
RPBASIC-52 V1.0
Copyright Intel (1985) and Remote Processing
Bytes free: 27434
```

Symbols and Terminology

NOTE: Text under this heading is helpful information. It is intended to act as a reminder of some operation or interaction with another device that may not be obvious.

WARNING:

Information under this heading warns you of situations which might cause catastrophic or irreversible damage.

W[-] Denotes jumper block pins.

< xxx> Paired angle brackets are used to indicate a specific key on your keyboard. For example < esc> means the escape key.

BASIC uses the decimal convention for designating addresses and data. There are times when hexadecimal notation is more convenient to use. Notation used in this manual and BASIC-52 is the 'H' character after the number. 8CH stands for 8C hexadecimal.

TECHNICAL SUPPORT

If you have a question about the RPC-320 or RPBASIC-52 and can't find it in this manual, call us and ask for technical support. Technical support hours are 9 AM to 4 PM mountain time.

When you call, please have your RPC-320 and *BASIC-52 PROGRAMMING MANUAL* ready. Many times it is helpful to know what the RPC-320 is used for, so please be ready to describe its application as well as the problem.

Phone: 303-690-1588

FAX: 303-690-1875

The RPC-320 uses a Dallas Semiconductor DS80C320 processor. Additional information can be obtained from Dallas Semiconductor (214-450-0448, FAX 214-450 0470), or your distributor.

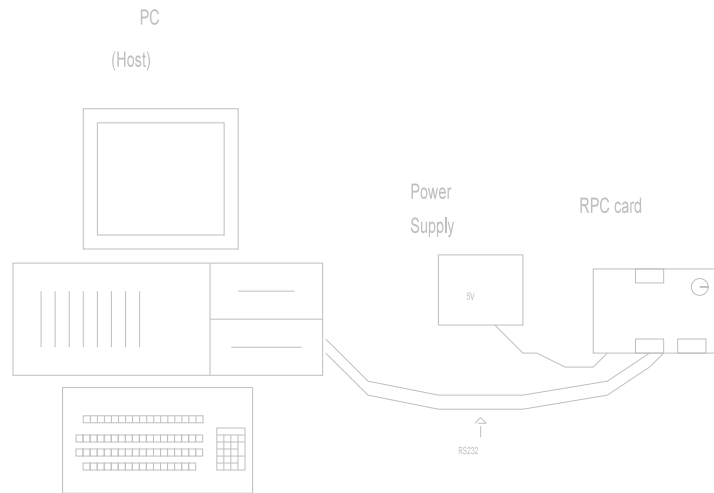

Figure 1-1 System layout

INTRODUCTION

The RPC-320 is ready to program as soon as you connect it to a terminal or PC and apply power. This chapter describes what is needed to get a sign- on message and begin programming.

Requirements for uploading and downloading programs are discussed. A "Where to go from here" section tells you what chapters to refer to in order to use the various capabilities of the RPC-320. Finally, a troubleshooting section helps out on the most common problems.

OPERATING PRECAUTIONS

The RPC-320 is designed to handle a wide variety of temperature ranges at low power. These characteristics require using CMOS components. CMOS is static sensitive. To avoid damaging these components, observe the following precautions before handling the RPC-320.

1. Ground yourself before handling the RPC-320 or plugging in cables. Static electricity

can easily arc through cables and to the card. Simply touching your PC before you touch the card can greatly reduce the amount of static.

2. Do not insert or remove components when power is applied. While the card is a + 5 volt only system, other voltages generated on the card which affect other components.

EQUIPMENT

You will need the following equipment to begin using the RPC-320:

- RPC-320 embedded controller
- PC with a serial port and communications program
- or a
- Terminal
- VTC-9F serial cable
- + 5, 200 ma power supply

Refer to *Chapter 4, SERIAL PORTS*, for wiring information to make your own serial cable.

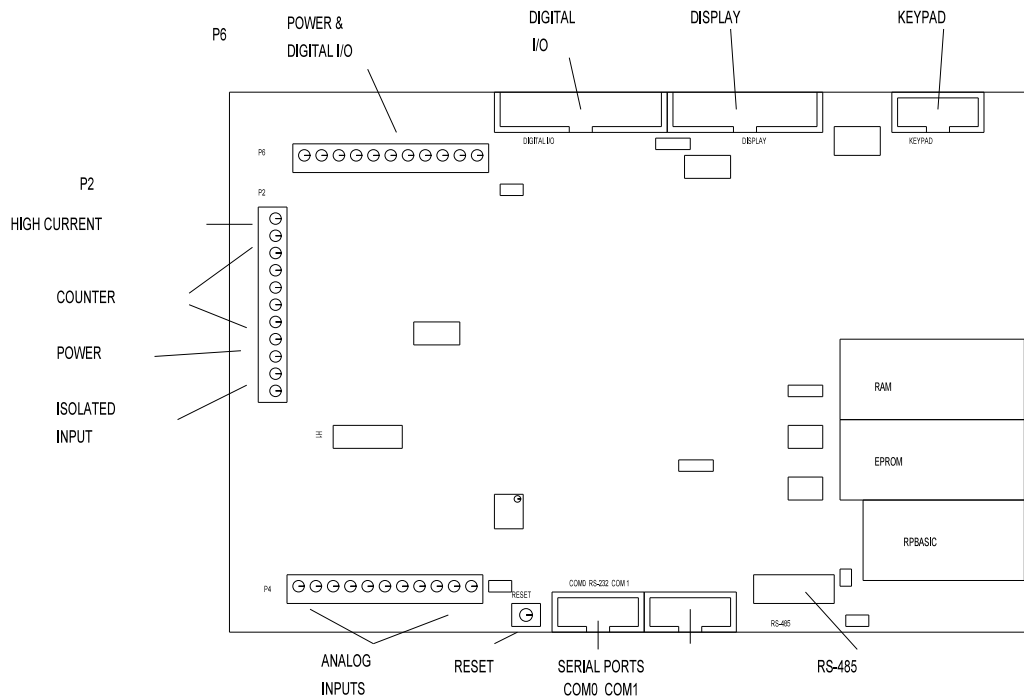

Figure 2-1 Connector location and function

FIRST TIME OPERATION

Become familiar with the locations of connectors before getting started. See Figure 2-1.

RPC-320 jumpers have been set at the factory to operate the system immediately. For first time operation, do not install any connectors or parts unless specified below. Jumpers should be kept in default positions.

1. Connect power.

The RPC-320 needs + 5 ±0.25 volts at 100 ma. Any well regulated supply that supplies this will work. Be careful when using "switching" power supplies. Some of these supplies do not regulate properly unless they are adequately loaded. Don't forget that power requirements increase when opto modules are used. G4 opto modules require up to 20 ma each.

Make sure power is off. Connect the power supply to one of the appropriately marked terminals on the RPC-320. There two power connectors: P2 and P6. Either one may be used to connect power.

2. Hook up to a PC or terminal.

You can use either a PC or CRT terminal to program the RPC-320. Connect one end of the VTC-9F connector to the 10 pin COM0 port on the RPC-320. Refer to Figure 2-1 for connector location.

Using a PC

Connect the VTC-9F serial cable to the PC's COM1 or COM2 port. You may need a 9 pin male to 25 pin female adapter. The VTC-9F is designed to plug directly into the 9 pin serial port connector on a PC.

Start up your serial communication program. Set communication parameters to 9600 baud, 8 data bits, no parity, 1 stop.

Using a Terminal

Follow your terminal instructions to set the baud rate to 9600 baud, 8 data bits, no parity, and 1 stop. You may need a 9 pin male to 25 pin male adapter to connect the VTC-9F.

3. Power up.

Turn on your power supply. On power up a copyright message is printed.

```
RPBASIC-52 V1.09
RPC-320
Copyright Remote Processing (1994)
Bytes free: 63740
```

```
65,536 bytes of additional expanded memory detected
512K byte EPROM installed
```

If a nonsense message appears, your terminal or PC may not be set to the appropriate communication parameters. If the system still does not respond, refer to *TROUBLESHOOTING* later in this chapter.

The sign on message may differ based on the RAM and flash EPROM installed.

4. Testing.

The system is now in the "immediate mode" and is ready for you to start programming. Type the following program:

```
10 FOR X=0 TO 2
20 PRINT "Hello ",
30 NEXT
40 PRINT
```

Now type RUN. The system will display:

```
Hello Hello Hello
```

```
READY
>
```

Terminate a program by typing a < Ctrl> -C.

UPLOADING AND DOWNLOADING PROGRAMS

Downloading programs means transferring them from your PC (or terminal) to the RPC-320. Uploading means transferring them from the RPC-320 back to the PC. This section explains how to do both of these procedures using generalized instructions for terminal programs (Procomm, Windows Terminal, etc.)

When uploading or downloading files, select ASCII text format. XMODEM, YMODEM, or other formats are not used.

RPBASIC-52 does not know when you are typing in a program or if something else (laptop or mainframe) is

sending it characters. The upload and download file does not contain any special codes; they are simply ASCII characters.

Uploading programs is simply a process of receiving an ASCII file. You or your program simply need to send "LIST" to receive the entire program. The default baud rate (9600) is rather high. The RPC-320's baud rate is changed using the CONFIG BAUD command.

Downloading a program requires transmitting an ASCII file. As you type in (or download) a line, RPBASIC-52 tokenizes, or compiles, that line. The time to do this depends upon its complexity and how many lines of code have been entered.

RPBASIC-52 must finish compiling a line before starting the next one. When a line is compiled, a "> " character is sent. This should be your terminal programs pacing character for downloading.

If your communications program cannot look for a pacing prompt, set it to delay transmission after each line is sent. A 100 ms delay is usually adequate, but your program may be long and complex and require more time. A result of a short transmission time is missing or incomplete program lines.

Editing programs and programming hints

Files uploaded or downloaded are simply ASCII DOS text files. No special characters or control codes are used. You may create and edit programs using your favorite word processor or editor. Just be sure to save files in DOS text format.

A technique used to further program documentation and reduce code space is the use of comments in a downloaded file. For example, you could have the following in a file written on your editor:

```
REM Check position

REM Read output from the pot and
REM calculate the position

2200 a = ain(0) :REM Get position
```

The first 3 comments downloaded to the RPC-320 are ignored. Similarly, the empty lines between comments are also ignored. Line 2200, with its comment, is a part of the program and could be listed. The major penalty by writing a program this way is

increased download time.

Notice that you can write a program in lower case characters. RPBASIC-52 translates them to upper case.

Some programmers put "NEW" as the first line in the file. During debugging, it is common to insert "temporary" lines. This ensures that these lines are gone. Downloading time is increased when the old program is still present. If you like to write programs in separate modules, you can download them separately. Modules are assigned blocks of line numbers. Start up code might be from 1 to 999. Interrupt handling (keypad, serial ports) might be from lines 1000 to 1499. Display output might be from 1500 to 2500. The programmer must determine the number of lines required for each section.

RPBASIC-52 automatically formats a line for minimum code space. For example, you could download the following line of code:

```
10 fora= 0to5
```

When you listed this line, it would appear as:

```
10 FOR A=0 TO 5
```

Spaces are displayed but not stored. The following line:

```
10 for a = 0 to 5
```

would be compressed and displayed as in the second example above. Spaces are removed. However, spaces as part of a remark or PRINT are not removed.

Instead of uploading and downloading programs, you can save them to the on card EPROM. This is useful if you are using a terminal to write programs. Simply type SAVE. To retrieve a program, type LOAD.

WHERE TO GO FROM HERE

If you want to do this:	Turn to Chapter
Save a program	3
Run a program at power up or reset (autorun)	3
Know more about serial ports	4
Install a different RAM memory chip	5
Using RAM to save variables	5
Run an assembly language program	5
Configure digital I/O lines	6
Detect on/off switch status	6
Use high current outputs	6
Connect an external opto rack	6
Calendar/clock option	7
Connect Displays	8
Use a keypad	9
Measure voltages	10
Using interrupts	12
Multi-mode counter	13
Use low power operation	14

Refer to the table of contents for a more detailed listing.

TROUBLESHOOTING

You would probably turn to this section because you could not get the sign on message. If you are getting a sign on message but can't enter characters, then read section 5 below. The following are troubleshooting hints when you can't get anything.

1. Check the power source. If it is below 4.65 volts at the input power terminal, the RPC-320 will reset. Power is 5 ± 0.25 volts. Make sure it is a clean 5 volt source. If it dips intermittently to 4.65 volts (due to switching noise or ripple), the card will reset for about 100 ms. If the noise is frequent enough, the card will be in permanent reset. Check U7, pin 8. If it is high (about 5 volts), then the card is in reset. This line should be low (about 0 volts).
2. Check the COM0 port (J3). Remove the connector from COM0. Refer to the outline drawing earlier in this chapter. Connect an oscilloscope (preferred) or a voltmeter to pin 3 (Txd) and ground. Pin 3 should be -6 volts or more negative. (Pin 1 is designated by the \wedge symbol on the connector. Pin 3 is next to it, nearer the key opening.) If you have -6 volts or more, press the reset switch. If you have a scope

attached, you should see a burst of activity. With a volt meter, you should see a change in voltage. Using a Fluke 8060A set to measure AC, you should see a momentary reading above 2 volts.

3. Install the serial cable and make sure the voltages and output activity are still there. Output is from pin 3 on the VTC-9F. If not, check to make sure something is not shorting the output.
4. Check the serial parameters on your PC or terminal. They should be set to:

9600 baud, no parity, 8 data bits, 1 stop
5. If you are receiving a sign on message but not able to enter characters, check U8, pin 4 for at least -6 volts. When it is near 0 volts, the terminal or PC's Tx line is not connected. When you press a character on the terminal or PC, you should see the voltage go positive. Check the serial cable. Transmitted signals from the PC or terminal are from pin 5 on the 10 pin IDC connector.

If all of this fails, call technical support listed in chapter 1.

INTRODUCTION

Programs are stored in an EPROM in socket U6. You can store one or more programs, depending upon EPROM size. A BASIC program can call another when a 512K byte EPROM is used.

Maximum program size that can be run at any one time is about 62K, not including space for variables. 32K bytes is the maximum program size when a 29C256 IC type is used to save a program.

A conservative rule to determine program memory requirements is one line requires 40 bytes. 32K bytes would store 800 lines of code. Your application could be significantly more or less, depending upon the number of commands/line, comments, and print statements.

Despite the fact you may have a 128K or 512K RAM installed, the maximum program size RPBASIC-52 can run at one time is about 60K (including room for some variable storage). The table below shows the maximum capacity, maximum number of program lines, program size at one time, and number of programs for an EPROM type.

EPROM type	Max Cap.	Prog lines	Max Bytes	No. Progs
29C256	30K	400	32K	1
29C040	509K	12400	62K	8

One program can call another using the EXECUTE *n* command. *n* is from 0 to 7, depending upon the EPROM type.

NOTE: When a program calls another, the old program is completely replaced. All variables and arrays are cleared (set to 0).

To keep variables, you must save them before calling the new program. When the new program is running, these variables are restored. Use PEEK and POKE to read and save numbers and strings. See *Chapter 5, STORING VARIABLES IN RAM* for more information.

Binary data is saved and read from the EPROM using BSAVE and BLOAD commands. The EPROM has a limited number of write cycles (about 1000), so writing information should be kept to a minimum.

A flash EPROM is non-volatile (retaining data even when power is disconnected), having an unlimited number of read cycles and a limited number of write cycles (about 1,000). A program is not run from EPROM. It is transferred to RAM and run from there. Programs in RAM can be modified. They are saved to EPROM for execution later.

The RPC-320 can autorun on power up or reset by removing jumper (W9). When autorun is on, the program in EPROM segment 0 is loaded into RAM and begins to execute immediately.

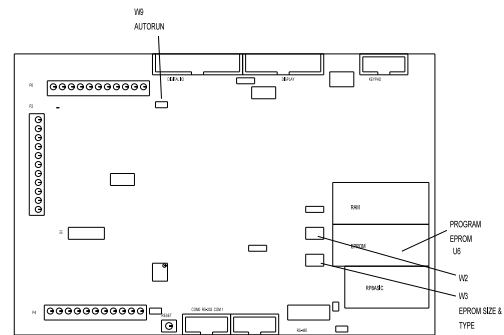

Figure 3-1 W3 autorun jumper

This chapter discusses saving programs to EPROM (U6) and program autoexecution.

SAVING A PROGRAM

For this example, assume you wanted to save the following program:

```

20 FOR N= 0 TO 2
30 PRINT "Hello ",
40 NEXT
50 PRINT
    
```

If this program is not already in, type it in now (or, if you prefer, use your own program).

Type in the following command:

```
SAVE
```

RPBASIC-52 responds with:

```

Saving 35 bytes
Verifying --- OK
    
```

The time it takes save a program depends upon the length and complexity of the program and flash EPROM type. Programming rate is roughly 600 bytes/second. If the program is not successfully saved to EPROM, an error message will appear.

Saving a program overwrites the previous one. There is no way to recover the old one since both occupy the same space.

Using SAVE without any parameters is the same as typing SAVE 0.

When a 128K (29C010) or 512K (29C040) EPROM is installed in U6, the SAVE *segment* parameter is 0 or 1 (128K) or 0 - 7 (512K). EXECUTE loads and runs the program in the segment specified by SAVE. A 32K (29C256) EPROM can run just one program.

Make the following modifications to the above program as instructed to see how one program can call another. There must be a 128K or 512K EPROM installed to run this code.

Add the following lines:

```
10 PRINT "Program segment 0"
60 EXECUTE 1
```

Now type:

```
SAVE 0
```

Now modify lines 10 and 60 as follows:

```
10 PRINT "Program segment 1"
60 EXECUTE 0
```

Now type:

```
SAVE 1
```

To see the programs operate, type RUN. To stop program execution, press < Ctrl-C> .

You may notice there is a slight pause between the printed hello's and program segment number. This is the time it takes to clear memory and load the program. Loading and clearing take approximately 0.25 seconds in a very small program up to 1 second in a very large program.

AUTORUNNING

To autorun a program:

1. Make sure there is a program in EPROM (from above). When using a 128K or 512K size EPROM, make sure the start up program was saved to segment 0.
2. Remove jumper W9.

Push the reset button. The program will run. If there are any errors, the program will stop (assuming you have not trapped them with ON ERROR) and display the error message. EXECUTE n is used within any program to load and run another program. The EPROM size must be a 128K or 512K.

PREVENTING AUTORUN

When troubleshooting a program, it's not always convenient for an autoexecute file to run. This is especially true if the program has been configured to ignore the < ESC> or < Ctl-C> keys.

To prevent autorun, install jumper W9 before power up or reset.

LOADING A PROGRAM

There are times when you may wish to temporarily modify or otherwise test out a change to a program. Since the program is loaded into RAM in autorun, modifications are made without affecting the program in EPROM. Use the LOAD or LOAD n comm and to transfer the EPROM program to RAM.

If you find out that modifications are not desirable or did not work, you can restore the original program to RAM using the LOAD command.

CHANGING EPROM SIZE

The RPC-320 can come with a 32K or 512K flash EPROM. The size may be changed at any time. Set W3 according to the type/size.

Type	Size Bytes	W3 Configuration
29C256	32K	[3-5], [4-6]
29C010	128K	[3-5], [2-4]

29C040 512K [1-3], [2-4]

To change the EPROM in U6, remove the IC and replace it with the new one. When installing a 29C256, pin 1 on the IC goes into socket pin 3. The top two rows of pins are empty.

ALTERNATE EPROMS

Flash EPROMs are more expensive than UV erasable or OTPs as of this writing. Large volume OEM's may wish to use lower cost EPROMs.

Program development must use flash EPROMs. When a program is finished, the flash EPROM is used as a master. Use an external program to duplicate programs.

Jumper W2 is normally configured for flash EPROM (W2[3-5] and W2[4-6]). For non-flash EPROMs, W2 is configured for [1-3] and [2-4]. Large volume OEM's should contact Remote Processing regarding pre-configuring W2 and W3 for your application.

COMMANDS

The following is a list of RPBASIC-52 commands used for saving, loading, and executing programs and data. These commands and functions are explained in the *Software Supplement* in this manual.

Command	Function
BLOAD	Transfers binary data from EPROM to RAM
BSAVE	Transfers binary data from RAM to flash EPROM
EXECUTE	Loads, clears memory, then runs a program from within a program
LOAD n	Loads a program from EPROM
SAVE n	Saves a program to flash EPROM

DESCRIPTION

The RPC-320 has two serial ports that interface to a printer, terminal, RS-485 network, or other serial devices. This chapter describes their characteristics and how to use them. Frequent references are made to commands listed in the *BASIC-52 Programming Manual* or *RPBASIC-52 Software Supplement* in this manual. Please refer to these manuals for more information about these commands.

Serial ports are numbered COM0 and COM1. COM0 is RS232 only and is used for program development. During run time, it can be used for other functions. COM1 is a general purpose port and is jumperable for RS-232 or RS-422/485.

Each port has a 256 character interrupt driven input and output buffer. This allows sending characters without slowing down program execution. However, if the PRINT buffer fills, program execution is suspended until all PRINT characters are in the buffer. Both ports have a 256 character input buffer. When more than 256 characters are received, excess ones are ignored.

CONFIG BAUD controls baud rate and RS-232/485 mode (COM1 only).

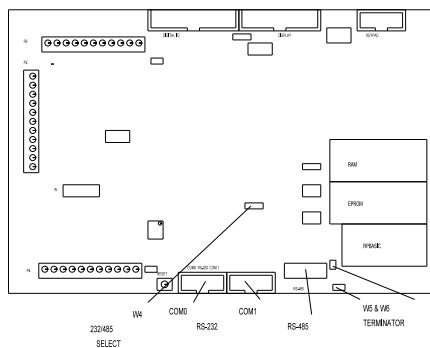

Figure 4-1 Serial port and jumper locations

ON COM\$ is useful when data is sent in packets. This multitasking command branches to a BASIC subroutine when a specific character or number of characters is received.

Another useful function is STR. Strings can be formatted, analyzed for length and content. When used in conjunction with ON COM\$, networking over RS-485 is much easier than with the original BASIC-52.

COM0 SERIAL PORT

This port uses a VTC-9F serial cable to connect external serial devices to the port. The cable consists of a 10 pin IDC connector wired one-to-one to a DB-9 connector. Line 10 is simply cut off. The pin out is designed so it plugs directly into the 9 pin serial port connector on a PC.

CTS is a output and is set to high on power up. Normally, this tells the other device to send data. The CTS line is set high or low to hold off communication. The sending device must have a RTS input. Line 400 sets CTS high and 500 sets it low, or to hold off.

```
400 LINEB 5,0,(LINEB(5,0) .AND. 247)
500 LINEB 5,0,(LINEB(5,0) .OR. 8)
```

COM0 is normally used for programming. During run time it may be used as a general purpose serial port. When used for programming or with the INPUT statement, it will accept ASCII character values from 0 to 127. When used with the GET function, it will return ASCII values from 0 to 255.

COM1 SERIAL PORT

COM1 is either an RS-232 or RS-422/485 port. A VTC-9F serial cable, described above, is used for RS-232 level communications. RS-485 is from screw terminals. COM1 has 2 hardware handshaking lines, CTS and RTS.

RTS is an input to the card. When RTS to the card is low, it usually indicates the sender does not want any data sent to it. The status of this port is read by the LINEB statement. The example below returns a status of the RTS line:

```
100 B = LINEB(5,1) .AND. 32
```

If B = 32, the sender is not requesting information and nothing further should be printed.

The CTS line may be set high or low to hold off communication from a sending device. The sender must recognize the CTS line. Line 400 sets CTS high and 500 sets it low, or to hold off.

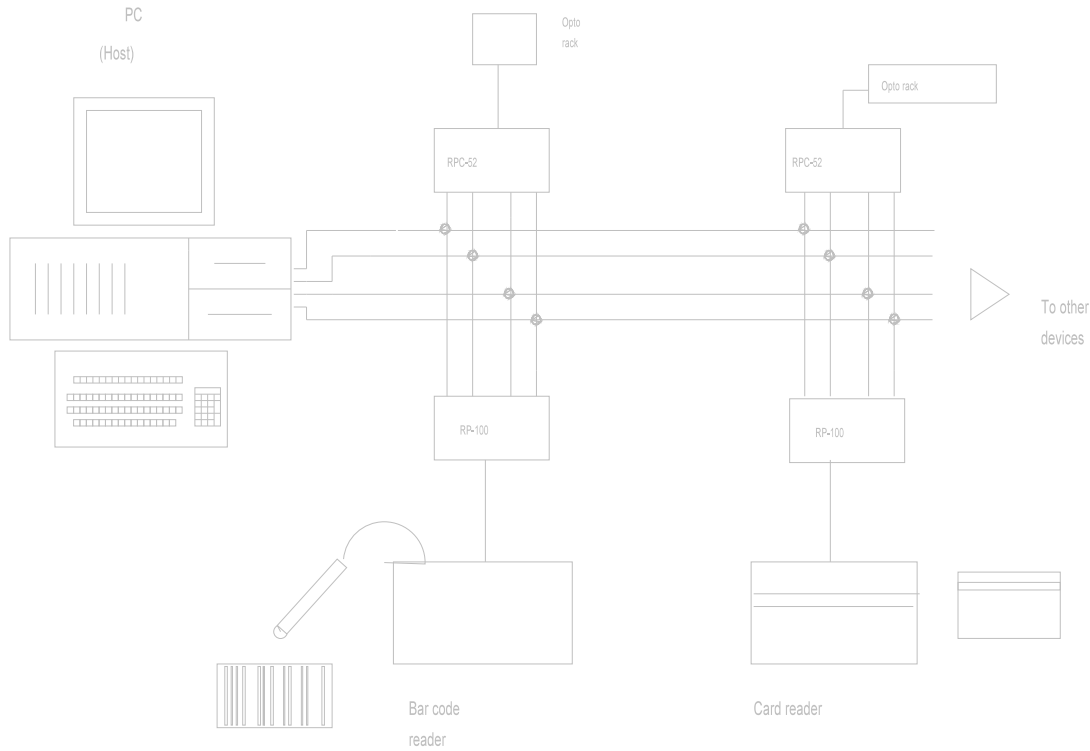

Figure 4-2 Network diagram

```
400 LINEB 5,0, (LINEB (5,0) .AND. 251)
500 LINEB 5,0, (LINEB (5,0) .OR. 4)
```

Jumper W4 determines if COM 1 receive is RS-232 or RS-422/485.

W4[1-2]	RS-485
W4[2-3]	RS-232 (de fault)

COM1 default is RS-232. Use the CONFIG BAUD statement to set the software to RS-422 or RS-485. When set to RS-422, the transmitter is always on. RS-485 mode turns on the transmitter only when sending.

RS-422/485 OPERATING INFORMATION

RS-422/485 Termination network

When the RPC-320 is the last physical unit on a network (RS-485), or it is the only unit (RS-422), the receiver must be terminated to prevent ringing. Jumper block W5, 6 installs or removes this network. Insert a jumper in W5 and W6 to install the network terminator.

Only one slave device on a RS-485 network should have a terminator installed. The host transmitter should also have a 100 ohm resistor in series with a 0.1 mfd capacitor. The terminator on the RPC-320 includes pull up and pull down resistors to prevent lines from floating and generating erroneous characters.

Two wire RS-485

The RS-485 port on the RPC-320 is set up for 4 wire mode. 2- wire mode causes transmitted data to be received. To use the RPC-320 in this mode, your code should "flush" the received data or otherwise remove transmitted information.

Mechanically, to make a 2- wire system, simply connect T+ to R+ and T- to R-. Make sure CONFIG BAUD is set up for RS-485 mode.

Multidrop Network

You can use the RPC-320 in a multidrop network by using COM1's RS-422/485 port. You can connect up to 32 units (including other RPC-320's) over a 4,000 foot range.

Figure 4-2 shows an example of a multidrop network. This network includes a host and one or more devices. The host transmits data packets to all of the devices, or nodes, in the network. A data packet includes an address, command, data, and a checksum. See figure 4-3. The packet is received by all devices, and ignored by all except the one addressed.

The relationship described below between nodes and the host is a master-slave. The host directs all communication. Nodes "do not speak unless spoken to". Peer to peer communication, while possible with the RPC-320, is not discussed here.

There are many communication protocols. For this example, a protocol might look something like this:

> 22MB1

The protocol starts with the < cr> character. This character synchronizes all units and alerts them that the next few characters coming down are address and data. In this case, "> 22" is the units address. "M" is the command and "B1" is the checksum. The command is terminated with a < cr> character.



Figure 4-3 Data packet

The response depends upon the nature of the command. Suppose the command M means "return a digital I/O port status". The RPC-320 could read the port and respond with AA2< cr> . The first A is an acknowledge, that is no errors were detected in the message. The data, A2, is a hex number and is broken down as follows:

```
Bit/line    7 6 5 4 3 2 1 0
Status      1 0 1 0 0 0 1 0 = A2
```

Lines 1, 5 and 7 are high while the others are low.

The following program fragment uses ON COM\$ and STR in a network environment. ON COM\$ generates an interrupt when a < CR> is received. The interrupt program uses a STR function to determine if the data packet was addressed to this card.

```
10 STRING 200,20
20 ON COM$ 1,0,13,1000
30 $(1) = ">05"
.
.
.
1000 $(0) = COM$(1)
1010 A = STR(8,$(0),$(1))
1020 IF A = 0 THEN RETURN
.
.
```

Line 20 sets up ON COM\$ to interrupt on a < CR> and branch to line 1000. Line 30 sets up this card's address.

Line 1010 checks to see if the received message = this card's address. If not, the subroutine ends. When there is a match, further processing is performed.

ACCESSING SERIAL BUFFERS

You can access COM0 and COM1 buffers in three ways:

1. INPUT statement. This removes all characters in the buffer up to the terminator character and puts them into a variable.

When using the INPUT statement, program execution is suspended until a < cr> (Enter key) is received. Whether this is a problem depends on your particular application.

INPUT strips bit 7. This means ASCII characters from 0 to 127 are received.

2. GET function. Characters are removed one at a time as an ASCII value. A 0 is returned when the buffer is empty. Use the COM function to determine if the buffer is empty or if a 0 is an ASCII value. Use UIn to select the serial port for GET.

If you don't read the buffer and the buffer fills, all subsequent characters are discarded.

3. COM\$(n) retrieves all characters in the buffer, including other control codes (except CR).

ACCESSING COM0 AND COM1

INPUT and GET functions retrieve data using the UIn command. UI0 routes inputs to COM0 while UI1 inputs from the COM1 port. PRINT outputs are set by the UOn command. UO0 prints out COM0 while UO1 outputs COM1 using the PRINT command. PRINT #1, is an alternative way to print to COM 1.

The following show how UIn and UOn work.

```

100 UI0          Set to COM0
110 INPUT A      Get data from COM0 port

520 UI1          Switch to COM1 port
530 INPUT B      Get data from COM1 port

800 REM          Print to COM0
810 PRINT "Temperature:",T

900 REM Print to COM 1
910 PRINT#1, "Set pressure at:",CA
    
```

Power up default is set to COM0.

DISABLING CONTROL-C

Program execution is terminated by entering a < Cntl> < C> . To disable < Cntl> < C> so program execution is not terminated, execute the following statement:

```
DBY(38) = DBY(38) .OR. 1
```

COMMANDS

The following is a list of RPBASIC-52 commands used for serial I/O. These commands and functions are explained in the *BASIC-52 Programming Manual* and *RPBASIC-52 Software Supplement* in this manual.

Command	Function
CLEAR COM\$	Clears serial input buffer
COM\$	Returns string from buffer
COM	Returns number of characters in buffer
CONFIG BAUD	Sets serial port parameters
GET	Returns a character from the serial buffer
INPUT	Receives string from port
LIST	Outputs program listing
PRINT	Outputs data in various formats
PRINT #,	Prints to a specified port
SPC	Print out n number of spaces
STR	String handling commands
TAB	Tabs to predetermined positions
UI0	Reroute inputs to COM0
UI1	Route inputs to COM1
UO0	Reroute PRINT statement to COM0
UO1	Route PRINT statement to COM1
USING	PRINT formatting statement

SERIAL PORT PIN OUT

Pin outs for J1 and J2 are shown below. Unused pins are open.

J1 & J2	Name	Direction from card
3	Tx	Out
4	RTS*	In

5	RXD	In
6	CTS	Out
9	Ground	
10	+ 5	

*RTS input not in COM0.

A serial cable is made by simply taking a 10 pin female IDC connector and crimping a 9 wire ribbon cable to it.

INTRODUCTION

32K, 128K, or 512K of RAM may be battery backed on the RPC-320. RAM size can be changed at any time. RAM is in socket U5.

RAM is backed up when a DS1216DM is installed. Battery life depends upon RAM size, its power consumption, ambient temperature, and amount of time the board is operating. Generally, a battery life of about 3 to 5 years is expected. Operating the board at 50°C reduces battery life by 1/2.

The DS1216DM is also a real time clock. Thus, DATE and TIME functions and commands are available when it is installed. See *Chapter 7* for more information.

This chapter discusses changing RAM, saving and retrieving variables, running assembly language programs, and battery condition. Figure 5-1 shows the location of U3 and jumper W1.

Increasing RAM size does not necessarily increase the program size RPBASIC-52 can handle. Maximum program and variable size is 60K. Additional RAM does increase the amount of space available for PEEK and POKE storage.

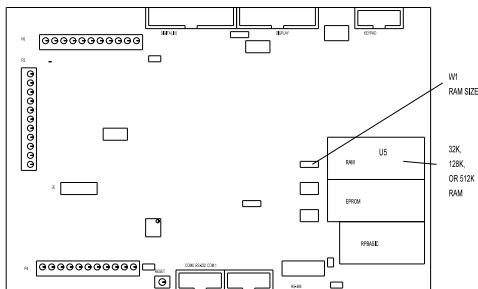

Figure 5-1 RAM and W1 jumper location

CHANGING MEMORY

Different types of memory can be installed at any time. RPC-320 models come with either 32K or 128K of RAM installed. Maximum is 512K.

To change a memory chip, you need to remove the original chip, install the new one, and set jumper W1.

To install a new memory chip:

1. Turn off power to the RPC-320.
2. Remove the memory chip from U5.
3. Orient the chip so pin 1 is towards the inside.

If installing a 32K RAM, place the chip at the bottom of the socket (memory chip pin 1 goes into socket pin 3). The top two socket pins in each row are empty.

If installing a 128K or 512K, install the chip into the socket.

4. Check and change, as necessary, jumper W1 to conform to the new memory.

RAM size	Jumper W1
32K	[1-2]
128K	[1-2]
512K	[2-3]

BATTERY BACKUP

An optional battery backup module may be installed. Principal is the same as installing a RAM chip.

WARNING:

An additional modification must be performed to the DS1216DM module when a 512K RAM is installed. Contact Remote Processing for details.

To install a module:

1. Remove the RAM IC in U5.
2. Install the DS1216DM in U5.
3. Re-install the RAM chip into the top of the module.

Checking the battery

Battery voltage is approximately 3.0 volts, measured between pin 16 (ground) and 30 (128K RAM), 14 and 28 (32K RAM), or 16 and 32 (512K RAM) on the IC itself (not the circuit side of the board). Be sure to power up the RPC-320 once to activate the battery backup circuit in the module.

RESERVED MEMORY

Many control systems use process variables that are operator entered. "variables" in this context include numbers, strings, arrays, recipes, or formulas as applied to your application. They are not a part of the variables used by Basic. Process variables are accessed by PEEK and POKE type statements.

The upper 512 bytes of memory are set aside for this purpose in a 32K RAM system. In 128K and 512K RAM systems, all of the first 64K of RAM is used for program and variable storage. Process variables in these larger versions are stored starting at segment 1 and higher.

When the combined program and data size exceed 30K, a 128K or 512K RAM is necessary. Additional RAM is necessary when your program has large arrays and / or string storage requirements.

MTOP should not be used when variables are battery backed for power off conditions. Basic clears all of RAM in segment 0 (except for the last 512 bytes in a 32K system) at power up. Store process variables starting at segment 1 or higher in a 128K or 512K RAM system or start at address 7E00H, segment 0 in a 32K RAM system.

STORING VARIABLES IN RAM

Programs and RPBASIC-52 variables reside in segment 0. Data is generally stored in segment 1 and higher (a segment is 64K of memory). See memory map figure 5-2. "Data Area" is segment 1 or higher.

PEEK and POKE commands store and retrieve values from memory. For example:

```
20 POKEB1,12,A
```

puts the 8 bit value of A into segment 1, address 12.

Use the PEEK statement to retrieve the variable:

```
50 B = PEEKB(1,12)
```

Accessing reserved memory in a 32K RAM system is accomplished as follows:

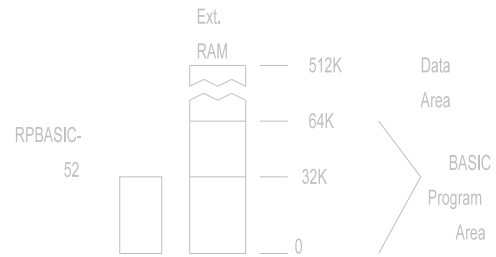

Figure 5-2 RPBASIC-52 memory map

```
100 POKEB0,7E00H,C
120 B = PEEKB(0,7E05H)
```

The highest address in a 32K RAM system is 7FFFH.

Many times it is desirable to store an array containing a "mixed" set of variables. Suppose you needed to save an array made up of the following elements:

Bytes	Type	Description
1	Byte	Job counter
2	Word	Analog output offset
6	Floating	Correction factor
20	String	Job name

Total number of bytes required for each array is 30 (add 1 for a < CR> at the end of the string).

The Job counter is incremented every time it is completed. Analog output offset is an output constant or other variable used to initialize the outputs. Job name is used with the display to identify a job.

For this example, suppose there are 20 of these arrays that need to be set up. A program fragment is as follows:

```
100 STRING 400,20 Initialize 20 string arrays

300 NO = 12           Element to fill
310 CF = 23.432       Correction factor
320 JC = JC + 1       Job counter
330 AC = 25           Analog offset
350 GOSUB 1000

500 NO = 5            Element to retrieve
```

510 GOSUB 2000 Retrieve variables

This subroutine stores variables CF, JC, and AC into an array starting in segment 1, address 0.

```
1000 POKEB1,30*NO,JC
1010 POKEW1,30*NO+ 1,AC
1020 POKEF1,30*NO+ 3,CF
1030 POKE$1,30*NO+ 9,$(0)
1040 RETURN
```

Subroutine 2000 - 2040 retrieves data into variables CF, JC and AC.

```
2000 JC = PEEKB(1,30*NO)
2010 AC = PEEKW(1,30*NO+ 1)
2020 $(1) = PEEK$(1,30*NO+ 9)
2030 CF = PEEKF(1,30*NO+ 3)
2040 RETURN
```

You can store and retrieve strings and variables in this way. There are many variations of PEEK and POKE statements. Refer to the RPBASIC-52 Software Supplement in this manual for additional information and examples. A list of commands appears at the end of this chapter.

BLOCK DATA TRANSFER

Blocks of data are transferred to and from RAM and flash EPROM using BLOAD and BSAVE commands. Block transfers are useful for loading and storing data, look-up tables, text, etc. Up to 65,535 bytes can be moved from RAM to EPROM or EPROM to RAM at one time. The absolute number of bytes that are moved is limited by the RAM and EPROM sizes.

Transfers from EPROM to RAM, using BLOAD, take approximately 23.5 ms/1000 bytes. Transfers from RAM to EPROM, using BSAVE, are even longer at 100 ms/1000 bytes using a 512K byte EPROM. This time is even longer when smaller EPROMs are used (due to the programming algorithm).

Serial port, tick timer, and external interrupts are enabled during these transfers. However, responses to ONTICK or ONITR are delayed by the time it takes to transfer data. When ONTICK or ONITR must be serviced faster, transfer data in smaller blocks.

Refer to BLOAD and BSAVE in *Appendix A* for more information.

ASSEMBLY LANGUAGE INTERFACE

Assembly language programs must be placed in the RPBASIC-52 EPROM. When using RPBASIC-52, programs should start at address 6000H or higher up to 7FFFH.

RPBASIC is normally in a 32K byte EPROM (27C256). A 64K byte EPROM (27C512) may be used in socket U4 provided the following modification is made: Cut the trace between W11 pins 1 and 2 on the circuit side. (Jumper W11 is under socket U4. Pin 1 is designated by the square pad.) Solder a jumper between W11 pin 2 and 3.

Documented assembly language interface calls listed in the Intel *MCS BASIC-52 Users Manual* will not work with RPBASIC-52. This is because RPBASIC-52 has been reassembled and code shifted around.

The RP-10 adapter board is used to run and debug assembly and C code. This board plugs into RAM socket U5 and RPBASIC socket U4. It does not use the Basic at all.

COMMANDS

The following is a list of RPBASIC-52 commands used with RAM.

Command	Function
BLOAD	Transfers data from EPROM to RAM
BSAVE	Transfers data from RAM to EPROM
CALL	Calls an assembly language routine
CBY	Returns code memory data
DBY	Returns or assigns internal memory
MTOP	Sets top of RAM memory
PEEK B	Returns a byte
PEEK F	Returns a floating point number
PEEK W	Returns a 16 bit value
PEEK \$	Returns a string
POKE B	Stores a byte
POKE F	Stores a floating point number
POKE W	Stores a 16 bit value
POKE \$	Stores a string
XYB	Returns or assigns external memory

INTRODUCTION

Digital I/O lines are used to interface with opto-module racks, switches, low current LED's, and other TTL devices. The RPC-320 has 34 of these lines. 8 TTL I/O lines go to a terminal strip. Additionally, there is one high current output and an opto-isolated input. Refer to the figure below for the location of these lines.

Eight lines at P6 are intended for general purpose TTL I/O such as switches, level sensors or to drive other devices.

A 24 line connector, J3, is intended to interface to opto racks or other TTL devices. 8 of these lines are high current outputs, capable of sinking 75 to 200 ma. Opto modules on an opto rack sense presence of AC or DC voltages or switch them.

L8 at P2 is a "zero" ohm FET switch. It is intended for switching LED back lighting on an LCD display. This line may also be used to switch high current, high voltage power. It can switch up to 2 amps.

ISOA/B is used as an isolated input as well as an interrupt.

In addition to the 24 I/O lines from J3, the display port can be used as digital I/O. Refer to Chapter 8 for more information.

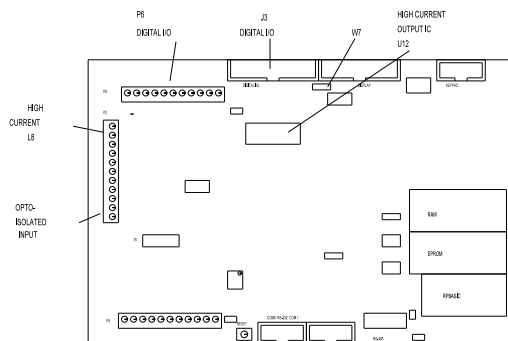

Figure 6-1 Digital I/O

WARNING:

Apply power to the RPC-320 before applying a voltage to the digital I/O lines to prevent current from flowing in and damaging devices. If you cannot apply power to the RPC-320 first, contact

technical support for suggestions appropriate to your application. Power may be applied to ISOA/B at any time.

Several software commands support the digital I/O ports. ON LINE branches to a subroutine when a line changes. ON COUNT counts the number of high to low transitions at a digital line. Maximum counting rate is about 95 Hz. These commands simplify design and greatly speed up execution. See *Appendix A* for more information.

DIGITAL I/O PORTS

All ports use an 82C55 for I/O. Lines are accessed using LINE or LINEB commands. Lines at J3 and P6 are configured for inputs or outputs using the CONFIG LINE command. See *Appendix A* for information.

WARNING:

When using CONFIG LINE, output lines go low momentarily (less than 10 micro-seconds) until they are set high again as per the data in the command line. Some other lines are affected when CONFIG LINE 0 is executed. Refer to CONFIG LINE command in *Appendix A* for more information.

Digital Port J3

This port is used to interface opto modules (using the MPS series racks), drive small relays, solenoids, motors, or lamps, and provide general purpose TTL I/O to other logic devices or mechanical switches. The LINE command is used to access and control this port.

The lines on J3 are divided into 3 eight bit groups from an 82C55. Ports A and B are configured as all inputs or outputs. Port C is programmed as one group of 8 inputs or outputs or as two groups of four lines (upper and lower C). The four lines in upper and lower C can each be programmed as all inputs or outputs. Refer to Table 6-1 to determine the opto channel or J3 pin number for a port. Use CONFIG LINE 100 (*Appendix A*) to configure ports A, B, and C for inputs or outputs.

When a line is configured as an output, it can sink a maximum of 2.5 ma at 0.4V and can source over 2.5 ma. Outputs sink 15 ma at 1.0V. This will drive opto modules. Port B is connected to a high current sink through U12. See "High current output" later.

Digital I/O lines at J3 may be pulled up to + 5 volts or to

ground through a 10K/100K resistor packs using jumper W7. 10K is on digital port A only.

Jumper W7 for pull up or down configuration is as follows:

W7[1-2]	Pull up
W7[2-3]	Pull down

Setting W7 for pull up makes interfacing to switches and "open collector" TTL devices easy. See "Interfacing to Switches and other devices" below.

Digital Port P6

Connector P6 has 8 digital I/O lines for general purpose use. Additionally, 3 ground and a + 5V positions are provided. + 5V power and ground may be brought in or taken from this connector. Lines are numbered L0-L7.

This port may be used to interface switches, drive small LED's, and provide general purpose TTL I/O to other logic devices. Voltage and current parameters are the same as J3 except there is no high current output. Port C from an 82C55 is used for this I/O.

Upon power up or reset lines L0 to L3 are inputs while L4 to L7 are outputs. Lines L4 and L5 are low while L6 and L7 are high at power up. All lines are connected to a 10K pull up resistor (R21). Lines are reconfigured for all inputs or outputs using the CONFIG LINE 0 command, found in Appendix A.

High Current Port L8

L8 will switch 2 amperes to ground through a "zero ohm" FET switch. Maximum off voltage is + 50 volts DC. "ON" resistance is about 0.5 ohm.

Use this port to switch LED back lighting for LCD displays on or off under software control.

This line is always an output. Use the LINE 8 command to turn this line off or on.

```
LINE 8,ON
LINE 8,1
```

Both commands turn on L8.

The FET switch is rated for much higher current. However, continuous current is much less without a heat sink attached. You may draw more than the rated 2 amps on an intermittent basis. How much and for how long depends upon your application. A quick way to check for excessive current is to touch (VERY CAREFULLY!) Q2 (next to P2). It can be warm to hot

to the touch. Consider the maximum ambient temperature the board will operate at. At 70°C, warm to the touch at room temperature may be too much. Consider adding a heat sink.

The PWM command may be used with this port. Use the circuit in Figure 6-2 when switching inductive loads. Use the "GND" terminal next to L8 when switching loads.

Optically Isolated Input

ISOA and ISOB are inputs to an optical isolator. This input is read as L8. It can also generate an interrupt provided W8[1-2] is jumpered and ONITR is set. Refer to *Chapter 12* for input voltage and interrupt requirements. This line can be used to "wake up" the CPU from low power IDLE 2 mode.

The status is read using the LINE(8) function.

```
A = LINE(8)
```

A 1 is returned when there is no input and a 0 when voltage is sufficiently high enough to turn on the isolator (about 3.5 volts).

The opto isolator is not polarity sensitive. This input can be used in conjunction with or independently of the ONITR statement.

Digital I/O Commands

The CONFIG LINE statement is used to configure lines at J3 and P6 for inputs and outputs. J3 power up default is all inputs. P6 power up default is L0 to L3 are inputs and L4 to L7 are outputs. CONFIG LINE 0 refers to P6 while CONFIG LINE 100 to J3.

The LINE command has 3 variations: LINE, LINE B, and LINE #. Each is described below. See *Appendix A* for more information.

LINE function and statement is used with MPS-XX opto rack at J3. It accesses a module according to the position number printed on the MPS board. Lines are numbered from 100 to 123. The opto module number used in this command is computed by adding 100 to the board position number. LINE also accesses L0-L8 on P2 and P6.

The LINE B function and statement is used to access

digital I/O lines 8 bits at a time. The address for port A is 0, B is 1, and C is 2. J3 I/O bank number is 3. Address for lines L0-L7 at P6 is 2 and I/O bank number is 5.

LINE # function and statement accesses lines according to the pin number at J3. J3 lines are numbered from 101 to 125. The line number used in this command is computed by adding 100 to the connector pin number. Line 102 is not allowed as it is the + 5V supply. See table 6-1 to correspond a pin number to a port and opto rack position.

P6 lines are numbered 0 to 7, and correspond to the terminal number on the board. The LINE function and command are used to access these lines. L8 at P2 is a high current output and is accessed using LINE 8. The status of ISOA/B is returned using LINE 8 function.

LINE, LINE B and LINE # return a 'true' logic level. A '1' indicates + 5 volts or high and a '0' is low or ground. LINE B and LINE # output true logic levels. LINE, however, outputs inverted logic. In order to turn on an opto module, a line must go low. However, to turn on a module using LINE, specify '1' or ON. High current output chip U 12 inverts control signals sent to it, regardless of command.

```
100 LINE 118,1      :REM Turn opto 118 ON
110 LINE 118,ON    :REM Turns opto 118 ON
120 LINE#104,0     :REM also turns 118 ON
```

ON LINE is a multitasking command. When active, the RPBASIC operating system checks the specified line every 5 ms. If the line changed state from the previous scan, a software interrupt is set. Upon completion of the current BASIC command (and assuming no other interrupts are active), program execution branches to a specified subroutine. This command is useful for monitoring lines, such as limit or door switches, that may not change often or when the program structure make it unwieldy to check lines frequently.

Another multitasking command, ON COUNT, causes the operating system to check the specified line every 5 ms. Up to 8 lines are monitored. If the line changed from a high-to-low state, a counter is incremented. Maximum counting rate is effectively 95 Hz. This command has two variations. One causes a software interrupt when a specified number of counts is reached. Another simply counts pulses at a line. The COUNT function returns the number of pulses since ON COUNT was initiated. See *Appendix A* for command information.

ON COUNT and ON LINE do not necessarily have to be input lines. They can be outputs controlled by another part of the program.

High Current Output

Eight lines at J3 can be used as high current drivers. These outputs will switch loads to ground. Outputs are controlled by Port B on the 82C55.

Logic outputs are inverted. That is, when a 1 is written to the high current port, the output is switched on and goes low.

The output driver chip, U 12, can be replaced with a DIP shunt jumper so it is like the other lines at J3. To do this, remove U12. Install a DIP shunt so pin 1 goes to pin 18. Pins 9 & 10 are open.

NOTE: Outputs at the high current lines are not compatible with TTL logic levels and should not be used to drive other logic devices.

Each of the high current outputs can sink 500 ma at 50V. However, package dissipation will be exceeded if all outputs are used at the maximum rating. The following conservative guidelines assume the number of outputs are on simultaneously:

# of outputs on	Maximum current per output
1	500 ma
2	400 ma
3	275 ma
4	200 ma
5	160 ma
6	135 ma
7	120 ma
8	100 ma

The thermal time constant of the package is very short, so the number of outputs that are on at any one time should include those that overlap even for a few milliseconds.

Incandescent lamps have a "cold" current of 11 times its operating current. Lamps requiring more than 50 ma should not be used unless a series resistor is installed.

Protection diodes must be used with inductive loads. Refer to figure 6-2

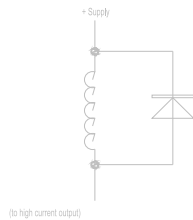

Figure 6-2 Inductive load protection

Do not parallel outputs for higher drive. This could result in damage since outputs will not share current equally.

The outputs at U12 are open collector. An external device must supply power.

Interfacing Digital I/O to an opto-module rack

I/O lines at J3 can interface to an MPS-8, 16, or 24 position opto module rack. Lines not going to an opto module connect to a screw terminal on the MPS-XX series boards. This feature allows you to connect switches or other TTL type devices to the digital I/O lines. The MPS-XX series boards accept G4 series modules.

A CMA-26-24 connects J3 on the RPC-320 to the MPS-XX board. Cable length should be less than 2 feet. Excessive cable lengths cause a voltage drop and consequently unreliable operation. Make sure + 5 V and ground is connected to the MPS-XX racks.

Before a line is set, the 82C55 chip must be initialized. This is done using the CONFIG LINE statement. Group inputs and outputs together. Refer to Table 6-1 for opto module position, port number, and connector pin out. If opto channels 16-23 are used, U12 should be replaced by a DIP shunt jumper.

The LINE and LINE # commands are used to control and access opto modules and lines. These commands are both functions and statements, depending upon how they are used.

100	LINE 100,0	Statement
110	LINE #103,0	Statement
120	A = LINE(100)	Function

130 A = LINE#(103) Function

Program line 100 turns external opto module rack position 0 off. Program line 110 sets J3, pin 3, to a logical 0 level. Program line 120 returns the status of external opto module rack position 0. If the module is "off", a 1 is returned (assuming it is an output module). Program line 130 returns the status of J3, pin 3 as a 0 or 1.

Example: To turn on opto module in slot position 8, the following command is executed:

LINE 108, 1

A '1' turns on a module while a 0 turns it off. (In actual fact, a 0 is written at the port.)

See *Digital I/O programming example* later in this chapter.

Interfacing to switches and other devices

Switches and other digital I/O devices may be connected directly to P6 or J3. The STB-26 terminal board provides a convenient way of interfacing switches or other digital I/O devices. Lines at J3 are connected to the STB-26 with a CMA-26 cable. Digital devices are then connected to the screw terminals on the STB-26. The MPS-XX series opto racks also provide a way to access digital I/O lines.

Switches may be connected directly to a line. When jumper W7 configures the resistors as pull ups, a switch closure to ground at a line is read as a 0 using the LINE # function at J1. 10K resistors are always pulled up at lines L0 to L7.

When W7 configures the input resistors as pull downs, one end of the switch must be tied to + 5 volts. If this is not possible or convenient, a 1K resistor can be tied between an input and + 5 volts to force it high when a switch is open.

Digital I/O programming example

The following example reads a switch at port A, bit 3 (J3-25) (program line 200), reads L1 at P6 (program line 210) and turns on opto module at channel 5 (program line 220). A LED is controlled through the high current port at J3-10 (port B, bit 0) (program lines 230 and 240). For testing, a 100 ohm resistor from J3-10 to + 5 volts can be substituted.

```
100 CONFIG LINE 100,13,1,1,1
200 D = LINE #(125)
210 F = LINE (1)
220 LINE 105, 1
230 LINE #110,1 :REM Turn on LED
240 LINE #110,0 :REM Turn off LED
```

Line 100 configured the 82C55 so ports A and C are inputs while B is the output.

Note that the LINE statement is used to control both opto modules and individual lines.

Lines can also be read or controlled in the immediate mode.

```
PRINT LINE#(125)
```

returns the status at J3-25. Notice that even when a line is configured as an output, its status can be read back.

Execute the following to control L7.

```
LINE 7,OFF
```

sets L7 low. Executing

```
LINE 7,ON
```

sets the line high.

LINEB is used to read and write a byte at a time.

```
LINEB 3,1,128
```

sets port B, bit 7 high and bits 0-6 are low.

Pulse Width Modulation (PWM)

Any line accessible by the LINE command may be pulse width modulated. PWM command parameters determine high and low time (to 5 ms resolution) and, optionally, number of pulses.

Use PWM to control the brightness of a display (via line 8), control the speed of a motor, or output a number of pulses to a stepper controller. Brightness control using LED's is best achieved when *htime* or *ltime* are less than 5 (25 ms). One of the parameters should be 1. Noticeable flicker occurs when *htime* and *ltime* sum to more than 6 (30 ms).

See the PWM command in the *Software Supplement* for more information. Use Table 6-1 to use an output directly from J3.

Table 6-1 Connector pin out - J3

Pin #	82C55	Description	Opto Channel
19	Port A, line 0		8
21	Port A, line 1		9
23	Port A, line 2		10
25	Port A, line 3		11
24	Port A, line 4		12
22	Port A, line 5		13
20	Port A, line 6		14
18	Port A, line 7		15
10	Port B, line 0	High current	16
8	Port B, line 1	High current	17
4	Port B, line 2	High current	18
6	Port B, line 3	High current	19
1	Port B, line 4	High current	20
3	Port B, line 5	High current	21
5	Port B, line 6	High current	22
7	Port B, line 7	High current	23
13	Port C, line 0	Lower C	0
16	Port C, line 1	Lower C	1
15	Port C, line 2	Lower C	2
17	Port C, line 3	Lower C	3
14	Port C, line 4	Upper C	4
11	Port C, line 5	Upper C	5
12	Port C, line 6	Upper C	6
9	Port C, line 7	Upper C	7
26		Ground	
2		+ 5V	

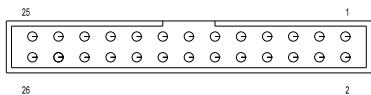

Figure 6-3 Digital I/O connector pin out (viewed from top)

COMMANDS

The following tables shows the RPBASIC-52 commands used for digital I/O.

<u>Command</u>	<u>Function</u>
CONFIG LINE	Configures I/O ports
COUNT	Returns number of pulses at a line.
LINE	Function returns status of an opto module as a 0 or 1.
LINE	Statement turns on or off an opto module.
LINE B	Function returns 8 data bits from any I/O type device.
LINE B	Statement writes 8 data bits to any I/O type device.
LINE #	Function returns status of line at J3 connector as a 0 or 1.
LINE #	Statement writes data to a line at J3 connector as a 0 or 1.
ON COUNT	Counts pulses and optional generates an interrupt.
ON LINE	Generates an interrupt when a line changes.
PWM	Sets PWM parameters for any line.

DESCRIPTION

An optional DS1216DM calendar/clock module may be installed in U5. The DS1216DM also battery backs RAM.

The DS1216DM from Remote Processing is a modified version of the Dallas DS1216D. An internal reset line has been cut. When a 512K RAM is installed, an additional line is cut and another soldered. Contact Remote Processing for details.

Battery life depends greatly upon the ambient temperature. Battery life degrades up to 50% at 50°C, using 25°C as a reference. RAM size and type also affect battery life. Generally, you can expect a battery life of 3 to 5 years.

Accuracy is about 1 minute/month and is not adjustable.

Hours are expressed in 24-hour format.

Refer to the RPBASIC-52 Software Supplement for more command information.

The clock module is installed by first removing the IC in U5. Then, install the DS1216DM into the socket. Install the RAM chip into the socket. When installing a 32K RAM chip, the top two pins in the DS1216DM are left open.

Refer to *CHAPTER 5* for information about using battery backed RAM and jumper setting when installing a 512K RAM.

WARNING: An additional modification to the DS1216DM is necessary when installing a 512K RAM. Contact Remote Processing for details.

SETTING DATE AND TIME

Set the date to turn on the clock module. Date and time are set while running a program or in the immediate mode. Date and time are treated as numbers and not strings. To set the date and time:

```
DATE 95,11,28
TIME 13,23,43
```

The time is set to 1:23:43 PM.

NOTE: The clock module is turned off as shipped from the factory. DATE and TIME functions return a HARDWARE error until DATE is set first.

To retrieve date and time as part of a program:

```
100 PRINT "Time: ",
110 FOR N=0 TO 2
120 PRINT TIME(N),
130 NEXT
140 PRINT "Date: ",
150 FOR N=0 TO 2
160 PRINT DATE(N),
170 NEXT
180 PRINT CR,
190 GOTO 100
```

run

Time: 13 24 12 Date: 94 11 14

When the clock module is missing, defective, or the date has not been set, a HARDWARE error (code 50 at address 101H) is returned by RPBASIC when a DATE or TIME function is performed. Use ONERR to trap for this error and report the problem.

COMMANDS

The following is a list of RPBASIC-52 commands for the calendar/clock.

Command	Function
DATE	Sets date and turns on module
DATE(n)	Returns date
TIME	Sets time
TIME(n)	Returns time

INTRODUCTION

RPBASIC-52 and the RPC-320 interface to a variety of displays:

- VF (vacuum florescent) character
- LCD (liquid crystal) character
- LCD graphics

Character display sizes range from four lines by 20 characters to four lines by 40 characters. The graphics display supports 160 x 128 pixels. Remote Processing supplies these displays with appropriate cables. A contrast adjustment for LCD character displays is built into the card.

If a display is not used, this port may be used for general purpose digital I/O. Port A and part of port B from an 82C55 are available. See *CONNECTOR DISPLAY PIN OUT* below for available lines.

The cable length to a display depends upon the amount of current it requires. A significant amount of voltage drop occurs with a long cable. Vacuum florescent and LCD graphics cables should be less than 2 feet. A character LCD display cable should be less than 5 feet.

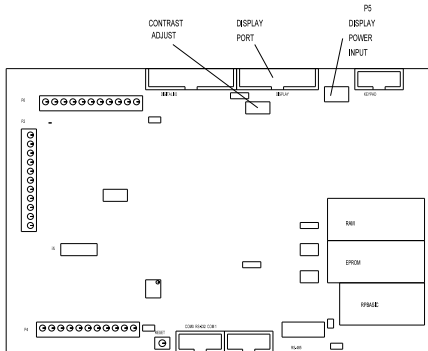

Figure 8-1 Display interface

CONNECTING DISPLAYS

The display port is designed to supply all the lines necessary for VF and LCD displays. A custom cable connects the RPC-320 to the display.

Displays purchased from Remote Processing include a cable. You simply connect the 20 pin connector to the RPC-320 LCD display port and the other end into the display.

Additional power wiring is usually required for LCD graphic and VF character displays. This information is included with the display. Information content is display dependent. Below is general information on both.

Graphic displays require additional voltages not generated on the RPC-320. These must be supplied externally. An external contrast adjustment may be necessary. You may be able to connect these through screw terminal block P5.

VF character displays require + 5 volts and ground to connector P5. This may in the form of external wires from the main power connector on the board or power supply.

Additional information for commands mentioned in the following text are found in the RPBASIC-52 Software Supplement in this manual.

WRITING TO THE DISPLAY

The display type must first be set using the CONFIG DISPLAY command. The DISPLAY command is used to print information.

PROGRAMMING EXAMPLE

The example below is for a four line by 20 character LCD display. Even though DISPLAY statements do not end with a comma (,), a < cr> < lf> sequence is not sent. Use CR to force a return to the beginning of the line. A CR does not scroll characters on a display. You must position the cursor to the next line.

```

10 CONFIG DISPLAY 1
20 STRING 200,30
30 $(0) = "Hello world"
40 DISPLAY (1,2),$(0)
    
```

DISPLAY TYPES

RPBASIC-52's software driver is based upon the characteristics of the display family. Compatible VF and LCD displays are shown below:

Manu fact.	Model	Type
Optrex	DMC 40457	LCD 4 x 40
Optrex	DMC 40202	LCD 2 x 40
IEEE	3601-90-080	VF 4 x 20
Optrex	DMF 682N	LCD 160W x 128D

DISPLAY CONNECTOR PIN OUT

The display port uses an 82C55 for data and control. The table below lists a pin number and its intended function. A display may not use all lines even though they are available.

J4 Pin	8255 Port/line	Function
1		Logic + 5V
2		Digital ground
3	A/4	D4
4		Contrast voltage
5	A/6	D6
6	A/5	D5
7	B/4	Reset (from inverter)
8	B/3	Write
9	B/2	Read
10	A/7	D7
11	A/1	D1
12	A/0	D0
13	A/3	D3
14	A/2	D2
15	B/7	CS (from inverter)
16	B/6	Command/ data
17	B/5	Halt
18		Contrast adjust
19		Alternate power
20		Power ground

J4 is available for additional I/O if a display is not used. Port A is configured as an input or output. Port B must be configured as an output if a 17 key or larger keypad is used. Use the LINE B command to access this part. I/O bank is 4.

Pins 18, 19, and 20 are for the LCD-5003 and other graphic displays.

COMMANDS

The following RPBASIC-52 commands are used for the display.

Command	Function
CLEAR DISPLAY	Clears entire display
CLEAR DISPLAY LINE	Clears current line
CONFIG DISPLAY	Specifies display type to use
DISPLAY	Prints the string at the row and column specified

The second example uses ON KEYPAD to generate an interrupt every time a key is pressed.

```
10 ON KEYPAD1000
.
.
.
500 GOTO 500

1000 PRINT KEYPAD(0)
1100 RETURN
```

Line 10 sets up the tasker for keypad interrupts to start at line 1000. Line 500 loops on itself for demonstration purposes.

Line 1000 prints out the key pad position pressed.

Elements of the previous program can be combined with this one to produce keypad strings.

KEYPAD PORT PIN OUT - J5

The keypad port uses ports B and C from an 82C55. Lower port C is configured as an input. Upper port C and port B bits 0 and 1 are outputs.

The table below lists J5's pin out, 82C55 port and bit, and its intended function.

Pin	82C55 Port/bit	Function
1	C/0	Row 1
2	C/6	Column 3
3	C/5	Column 2
4	C/1	Row 2
5	C/2	Row 3
6	C/4	Column 1
7	C/7	Column 4
8	C/3	Row 4
9	B/0	Column 5
10	B/1	Column 6

DESCRIPTION

The RPC-320 has 8 single ended analog input channels. These channels are used to measure voltages from transducers, 4-20ma current loops, thermistors, etc. Input voltage range is 0 to 5 volts or ±2.5V with 12 bit (4096 count) resolution. Signals are single ended or differential. Input impedance is 100K ohms to ground.

Reference IC U14 has a voltage output that corresponds to the IC temperature. This output may be used to measure ambient temperature.

Two amplifiers are available to signal condition inputs. By installing appropriate resistors and capacitors, inputs are buffered, amplified, and filtered.

This chapter begins with basic information on connecting and using analog inputs. Later, descriptions of how to measure voltages other than 2.5 or 5 volts, temperature measurement, data logging, using the amplifiers, and calibration are presented.

CONNECTING ANALOG INPUTS

All analog inputs interface through connector P4. Additional components, such as resistors and capacitors, may be connected directly to the screw terminals.

For greatest accuracy, connect unused inputs to ground.

R17 is adjusted to trim accuracy to your system. See *Calibration* later in this chapter for more information.

Temperature output or other signal input may go directly to channel 0 via header H1. See *Temperature Measurement and Amplifiers* below.

Overvoltage conditions

Inputs are protected over voltage protected. Maximum voltage on 1 channel is 25 volts. Maximum voltage for 2 to 4 channels is 12 volts. Total input current may not exceed 16 ma on all channels. Each channels input current is computed by the following formula:

$$I_{in} = (V_{in} - 5)/4700$$

When $V_{in} < 5$ volts, no current flows into the channel.

NOTE: An over-voltage condition on one channel

usually affects readings on other channels.

Grounding

Analog ground is somewhat isolated from digital ground. While the ground plane is connected between the two, analog ground is a virtual "island" connected only in one place to digital ground. To minimize noise pickup, the sending device should be connected to analog ground (located at the analog input terminal strip). When both analog and digital grounds come from the same device, you will have to play around with the grounds to determine which scheme provides the best performance for your system.

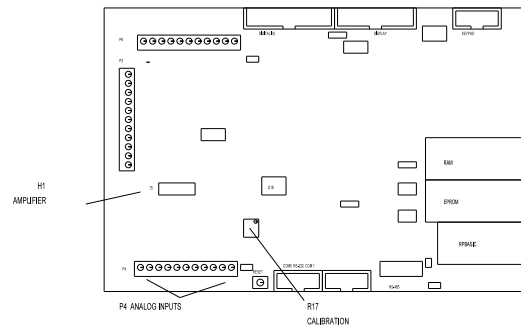

Figure 10-1 Analog I/O

INITIALIZATION

Each channel is initialized for 0-5V, single ended input upon power up. Inputs can be reconfigured for eight single-ended, four differential, or a mixture of single-ended and differential inputs. Input voltage ranges are 0 to 5V or ±2.5V for any single-ended channel or differential pair. Syntax is:

`CONFIG AIN channel,mode,range`

channel ranges from 0 to 7 for single-ended inputs. Differential inputs use adjacent channels.

mode defines single-ended or differential. 0 = differential, 1 = single-ended.

Differential inputs operate in a special way. The polarity of the input signal must be connected as shown for an even or odd *channel*. For example, when *channel* is odd (1, 3, 5, or 7), channel 0 must be more negative than channel 1 otherwise a 0 is returned. Should the relative polarity change, configure the even channel for differential input and perform an AIN on it. Use the

following tables for differential inputs.

When *channel* = odd

Pol.	-	+	-	+	-	+	-	+
CH #	0	1	2	3	4	5	6	7
<i>channel</i>	1		3		5		7	

When *channel* = even

Pol.	+	-	+	-	+	-	+	-
CH #	0	1	2	3	4	5	6	7
<i>channel</i>	0		2		4		6	

When *range* = 0, the input is ±2.5 volts and a 1 = 0 to 5 volts.

Differential Mode

When differential mode is specified, inputs are actually pseudo-differential. What this means is that a ground reference is needed. For example, you cannot place a battery between channel 0 and 1 and get an accurate reading. The (-) input must be referenced to ground. An example of where pseudo-differential works is an output from a bridge network.

A pseudo-differential input subtracts the DC component from an input. The IC maker recommends the (-) input remain stable within 1 count with respect to ground for best results. Connecting a 0.1 uF capacitor from the (-) input to ground works well.

When operating in differential mode, relative + and - voltages must be connected to specific inputs. When inputs are reversed, a conversion returns a 0. When the relative voltage changes, perform a conversion on the alternate channel. CONFIG AIN is performed on both channels.

Pairs of channels can be differential while others single ended. Thus, if channel 0 and 1 are differential inputs, channels 2-7 may be single ended.

Examples using CONFIG AIN

Below are sample syntaxes for CONFIG AIN

Differential, 0 to + 5V input

```
CONFIG AIN 0,0,1
CONFIG AIN 1,0,1
```

Perform a conversion as normal:

$$A = \text{AIN}(0)$$

The difference between channel 0 and 1 is returned. When channel 1 is more positive than channel 0, the result is zero. The difference is read on channel 1 by performing:

$$A = \text{AIN}(1)$$

Single-ended, ±2.5V input

```
CONFIG AIN channel,1,0
```

The result is 0 for -2.500V input, 2048 for 0.000V, and 4095 for + 2.4988V.

Acquiring Analog Data

Analog data is accessed with the AIN function. The syntax is:

$$A = \text{AIN}(\text{channel})$$

This function assigns the analog value of a channel to the variable; A in this case. The value returned is always in the 0 to 4095 range because the converter is 12 bits. Power up or reset default configures inputs to the 0-5V range, single ended.

To view the result of a conversion in the command mode, type:

```
print ain(0)
```

The result at channel 0 is returned. The returned value will always be in the 0 to 4095 range. When using a channel in the ±2.5V range, the value returned is interpreted differently. Zero count is now -2.500V, 4095 is + 4.9988, and 2048 is 0.000V.

Use the following formulas to convert a returned number to a voltage:

$$0 - 5V \quad A = .001221 * \text{AIN}(\text{channel})$$

$$\pm 2.5V \quad A = .001221 * \text{ain}(\text{channel}) - 2.5$$

The AIN function requires about 1.5 ms to convert the data. Additional time is needed to store the data. The example below takes 255 data samples and stores them

into an array which requires 6 bytes per entry. The second example takes only two bytes per entry, can save to extended memory, but requires a longer time to get a data point.

The program below takes about 1.5 ms per data point.

```
10 DIM A(254)
20 FOR X=0 TO 254
30 A(X) = AIN(0)
40 NEXT
```

This next program saves data above MTOP. MTOP was previously set. However, if you have 128K or more RAM, you can POKE into segment 1 or higher. It takes approximately 2 mS per data point and is not affected by the memory location saved to.

```
10 A = 30000
20 FOR X=0 TO 999
30 POKE W0,A,AIN(0)
40 A=A+2
50 NEXT
```

Data is retrieved using the PEEK W command.

Noise Notes

An input channel can appear noisy (change readings at random) if unused inputs are allowed to float. To minimize noise (and increase accuracy), connect all unused inputs to ground.

A high impedance input is, by definition, sensitive to voltage pickup. Noise is minimized by running wires away from AC power lines. A low impedance voltage source helps to reduce noise pickup. Shielded cable can help reduce noise from high impedance sources. Make sure the shield is not used for power ground. Using the shield for power ground defeats its purpose.

Wire pairs can also be twisted. 5-6 twists/foot provides a reasonable amount of noise cancellation.

Noise is defined in this section as any random change from a known input. The amount of noise you can expect under normal operating circumstances is ± 3 counts for any input range.

One way to compensate for noise is to take a number of samples and average the results. Taking 6 or more samples would, in theory, cancel out any effects of noise. A problem with this is noise tends to group together. Taking 6 readings at one time might show no change from the norm. Another 6 readings might be all high. If possible, try to spread out readings over a

period of time (several seconds if possible).

Another way is place a capacitor (0.1 to 1 mfd) between the input terminal and ground. This is useful when the source resistance is high.

Noise is, by definition, random. If you were to plot out the deviations from a norm, it would roughly resemble a bell shaped curve. Experiments on the RPC-320 have shown that 99% of the readings are within the ± 3 count reading and 60% are ± 1 count. Noise readings were made with all inputs shorted to ground.

Temperature Measurement

Reference IC U14 outputs a voltage proportional to its temperature. This information is used to determine approximate ambient temperature in order to turn on fans or heaters.

$$V_o = 2.1(T + 273)$$

or

$$T = V_o/2.1 - 273$$

or

$$T = V_c * .581428 - 273$$

Where T = Temperature in °C
 V_o = Output voltage in mV
 V_c = Count returned using AIN, 0 - 5V range

At 25°C the output voltage is approximately 625 mV, or 506 counts. V_o is expressed as a milli-volt number (625) not .625.

The output from U14 must be buffered. To measure temperature, jumper H1[1-3]. Remove resistor R13. Jumper H1[2-4]. Temperature is read at analog channel 0. The sensitivity is increased by jumpering H1[5-7] to ground. This will double the output voltage and any voltage changes due to temperature.

$$100 T = AIN(0) * .581428 - 273$$

T returns the temperature in celsius.

Sensitivity is increased by jumpering H1[5-7] to ground. This doubles the output voltage and any voltage changes due to temperature.

NOTE: Temperature measurements are approximate and are meant as a guide to indicate ambient temperature.

The output from the temperature sensor varies from unit to unit. Self heating effects as well as supply voltage will change the output.

The output voltage from the temperature sensor is doubled by jumpering H1[5-7]. While this does not change the range the unit operates at, it does change increase temperature measurement sensitivity.

Data logging on a timer tick

Some applications require that data is read at fixed intervals. The ONTICK construct is used to take data in intervals from 0.01 to 327 seconds. The example below takes 1 sample per second until 100 samples have been obtained.

```
10 DIM A(100)
20 ONTICK 1,500
30 REM THE REST OF YOUR PROGRAM
40 REM CONTINUES
80 GOTO 30
500 A(N) = AIN(3)
510 N=N+1
520 IF N = 100 THEN ONTICK 0,500
530 RETI
```

MEASURING HIGHER VOLTAGES

Voltages higher than + 5V are measured by inserting a series resistor to the input.

The table below shows resistor values for some input voltages using the 0-5V range.

<u>Maximum Input Voltage</u>	<u>Resistor</u>
6	20K
12.5	150K
24	380K

Use the following formula to determine the series resistance necessary for a maximum voltage input:

$$R_s = V_i * 20000 - 100000 \quad 0 - 5V \text{ range}$$
$$R_s = V_i * 40000 - 100000 \quad 0 - 2.5V \text{ range}$$

R_s is the resistor value in ohms in series with the input.
 V_i is the maximum input voltage. When R_s is negative or zero, a series resistor is not necessary.

A high R_s value can cause noisy readings. This is because the resistor acts as an antenna. To reduce noise, place a 0.1 mfd to 1 mfd capacitor between the input terminal and ground.

NOTE: When an input voltage exceeds the input range, other channel values are affected.

CONVERTING ANALOG MEASUREMENTS

Inputs are converted to "real numbers" by performing scaling calculations in the program. The AIN function returns values from 0 to 4095. To change these numbers into something more meaningful, use the following formula:

$$var = K * AIN(n)$$

n is the analog channel to read. *K* is the scaling constant. *K* is obtained by dividing the highest number in the range of units by the maximum AIN count (4095).

Example 1: To measure the results of an A/D conversion in volts and the voltage range is 0 to 5V, divided 5 by 4095 to obtain *K*.

$$K = 5/4095$$

$$K = .001221$$

Your program could look something like:

```
1000 C = .001221 * AIN(N)
```

Example 2: You want to measure a 0 to 200 PSI pressure transducer with a 0 to + 5V output. Divide 200 by 4095 to obtain the constant *K*.

$$K = 200 / 4095$$

$$K = .0488$$

The code can then look like:

```
1000 B = .0488 * AIN(0)
```

Measuring 4-20 mA current loops

Current loops is a convenient way to transmit a value and still assure the integrity of the signal. If the line should break, a 0 volt (or nearly so) is returned.

A 4-20 ma current loop is converted to 1 - 5V by placing a 250 ohm resistor across the input of the channel to ground.

Current loop readings are converted to engineering units by performing scaling as described earlier. Since the measurement range is 1 to 5V, the count range is reduced by 20% to 3276.

If pressure were measured:

$$K = 200/3276$$

$$K = .06105$$

There is one addition factor. Since the lowest value read is 1 V, this offset is subtracted from all readings. A 1 V offset is 1/5 of 4095 counts, or 819. The program line then becomes:

```
200 A=.06105*(AIN(N)-819)
```

Note that if the current loop line breaks, a negative value is returned.

AMPLIFIERS

Two operational amplifiers are available to signal condition inputs. Each amplifier is configured as shown below.

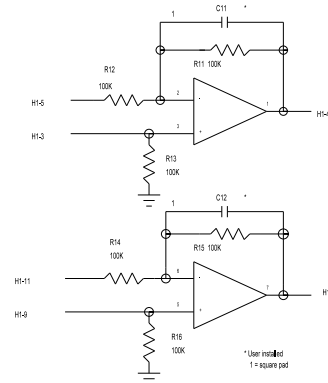

Figure 10-2 Amplifier circuit

Amplifiers are accessed through header connector H1. Pin out is as follows:

H1 pin	Function
1	Temperature output from U14
2	To channel 0 analog input
3	Non-inverting input, amplifier A
4	Output from amplifier A
5	Inverting input, amplifier A
6	Approximately + 7V supply (5 ma maximum)
7	Ground
8	Ground
9	Non-inverting input, amplifier B
10	Approximately -7V supply (5 ma maximum)
11	Inverting input, amplifier A
12	Output from amplifier A

Voltage outputs from pins 6 and 10 are generated by the RS-232 chip U8. Both of these voltages go through a 100 ohm resistor to H1-10 and H1-6. Pin 10 goes to 0 volts when operating the board in IDLE modes 1 or 2. Pin 6 goes to about + 5 volts. These voltages may be used to supply power to very low power amplifiers.

CALIBRATION

The A/D comes factory calibrated for a 0 to 5V input. This range is changed by adjusting R17. You can adjust the range to 5.12V. This is useful when the input is 0 - 5V and you want to know when the input is over-range.

To calibrate or adjust the voltage reference:

1. Connect the voltmeter ground to a GND point on the Analog IN terminal strip. Make sure there are no other connections to the analog ground.
2. Connect the voltmeter '+' lead to U14, pin 6.
3. Adjust R5 for 5.00 VDC or other voltage as desired. Do not exceed 5.2 or go below 4.8 volts.

COMMANDS

The following RPBASIC-52 commands are used for analog I/O. More information is found in the appendix of this manual.

Command	Function
AIN(n)	Returns analog value.
CONFIG AIN(n)	Configures analog input channels

DESCRIPTION

The watchdog timer is used to reset the RPC-320 if the program or CPU "crashes". The timer is built into the 80C320 CPU. Timed access requirements built into the CPU make it highly unlikely an errant processor would cancel a watchdog timer.

The watchdog should not be used in loops which do not end quickly or are of indeterminate duration unless a WDOG command is included. An example of an indeterminate loop is one that waits for a port condition to change.

The timer is set by executing a WDOG *n* command. *n* is 0, 1, or 2. 0 turns off the timer. 1 sets the watch dog time to 380 ms while 2 sets it to 2.8 seconds. Executing WDOG by itself resets the timer. WDOG must be executed periodically to prevent a reset.

When the watchdog times out, a software reset is performed. The effect is lines at J3 do not change as in a power-up or hardware reset. Lines at P6, display, and keypad port are reset to power-up conditions.

EXTERNAL RESET

The card is reset externally by momentarily shorting W10[1-2]. Reset is also achieved by shorting W10-2 to ground. Maintain this short for at least 10 ms. The card will then reset for about 350 ms.

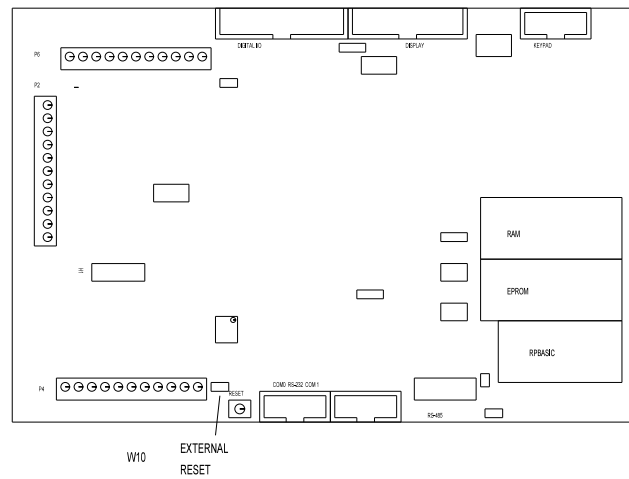

DESCRIPTION

There are two sources of interrupts the ONITR statement responds to: Internal and external. External interrupts are off-card. Internal interrupts are from the counter.

External interrupts are used to "wake-up" the card from any of the IDLE modes. This feature is useful in power conserving modes.

Signals to P2-ISOA and P2-ISOB are optically isolated. P2-INT is a non-isolated, TTL input. Only 1 interrupt is selected. Available interrupts are shown in the table below.

W8 P in	Description
1-2	External TTL level through P2 (INT) or optically isolated through P2 (ISOA & ISOB)
3-4	Carry or borrow pulse from counter
5-6	Carry pulse from counter
7-8	Borrow pulse from counter

ONINT selection is through jumper W8. This chapter describes using external interrupts P2-INT or ISOA/B. When a counter is used, then external interrupts may not be used. See *Chapter 14, Counter Inputs* for more information.

External interrupt at P2-INT is TTL level compatible. Bringing this line low generates an interrupt when ONITR is enabled.

OPTICALLY ISOLATED INTERRUPT

ISOA and ISOB provide an isolated, higher voltage input. Neither input is connected to ground or + 5V and is isolated to the card by at least 500 volts.

An external voltage of at least 3.5 volts, any polarity, will generate an interrupt. Higher voltages may be used provided a series resistor is in line to the supply. Use the following formula to determine the series resistor needed.

$$R_s = (V_i - 6) / .005$$

Where: V_i = input voltage

No series resistor is needed when R_s is negative.

INTERRUPT CHARACTERISTICS

Interrupts are negative going edge sensitive. This means an interrupt is detected when P2-INT goes low or when a voltage is applied to P2-ISOA and ISOB for at least 10 micro-seconds. To detect a subsequent interrupt, the line must go high at P2-INT or voltage removed at P2-ISOA/B for at least 10 micro-seconds.

The status of the interrupt or ISOA/B line is read using the following statement:

```
100 A = LINE(8)
```

When A = 1, P2-INT is high or no voltage is applied to ISOA/B.

The P2-INT goes to the output from the opto-isolator I1. Since this line goes to a 10K ohm pull-up resistor, additional devices can generate an interrupt only if they are "wired-or".

PROGRAM EXAMPLE

The following program enables interrupts and goes to a routine to service it. Jumper W8[1-2] and bring P2-INT to ground to see this example work.

```
10 ONITR 500
30 GOTO 30

500 PRINT "Got Interrupt"
510 RETI
```

Line 510 is necessary to re-enable **all** interrupts. If this line is not executed, but a RETURN is used, then ONTICK is also disabled. If your program requirements require disabling all interrupts for a time, then the RETI statement can be executed within any subroutine to re-

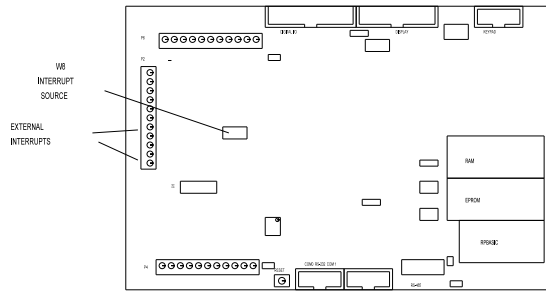

Figure 12-1 Optically isolated and TTL interrupts

enable interrupts.

DESCRIPTION

The 24 bit multimode counter is capable of up/down, binary, divide-by-n, and quadrature inputs. Count frequency is DC to 20 Mhz. The RPC-320 uses an LSI Computer Systems LS7166. Its data sheet is found in *Appendix C*.

The COUNT function and statement are used to read from and write to the counter. LINEB is used to program the chip for various operating modes.

An interrupt, using ONITR, may be detected on a carry, borrow, or either event. The event is jumper selectable through W8. When the counter is used, external interrupts (see *Chapter 12*) may not be used.

W8 P in	Description
1-2	External TTL level through P2-6 or optically isolated through P3
3-4	Carry or borrow pulse from counter
5-6	Carry pulse from counter
7-8	Borrow pulse from counter

Signals connect to the counter via P2. Use the following table to determine signal input to the LS7166.

P2 Name	Function
A IN	Count input A
B IN	Count input B
GND	Ground
LOAD	Load counter/latch (LCTR/LLTC)
GATE	Gate/reset counter (ABGT/RCTR)

Input lines (A IN), (B IN), LOAD, and GATE are pulled to + 5V through a 10K resistor.

PROGRAMMING

The LS7166 is capable of several operating modes, all of which are not discussed here. See *Appendix C* for this chips operating modes. What are shown are examples of how to program this chip.

NOTE: Be sure to initialize the counter chip before using COUNT commands. Failure to do so returns meaningless results.

The COUNT function returns the current counter value.

Specifically, RPBASIC writes a 2 to the MCR (Master Control Register), reads the 3 counter bytes from the OL (Output latch), and converts it to the proper internal BASIC format.

```
100 A = COUNT(0)
```

COUNT statement writes a 24 bit number to the PR (Preset register) only. Its syntax is:

```
200 COUNT 0,D
```

To transfer this number to the counter, execute the following in the program:

```
LINEB 6,1,8
```

The *counter* number is always 0 on the RPC-320.

LINEB is used to access specific registers within the chip. Accessing control and status registers is shown below. Counter bank is 6.

```
100 A = LINEB(6,1) : REM Read OSR
200 LINEB6,1,X
```

Line 200 writes to OCCR, ICR, QR, MCR, and ICR registers. Which register selected is determined by bits 6 and 7 in the byte written to the chip.

Program examples

This code resets the counter and enables the inputs. The count is printed once a second. To see the count change, momentarily bring "A IN" or "B IN" on P2 to ground. When "B IN" is grounded, the count decrements.

```
10 LINEB6,1,32
20 LINEB6,1,64+8
30 ONTICK 1,500
40 GOTO 40
500 PRINT COUNT(0)
510 RETI
```

Line 20 can be shortened somewhat. 64 selects the ICR (Input control register) and 8 enables inputs. 72 could have been used.

The following program example returns a frequency. Input signal is at "A IN".

```

100  LINEB 6,1,32
110  LINEB 6,1,72 : REM enable inputs
120  ONTICK 1,500
130  IDLE
140  GOTO 130
500  A=COUNT(0) : REM get count
510  C=A-B : REM figure change from last time
520  PRINT "Frequency = ",A
530  B=A
530  RETI
    
```

The first frequency read will always be a bit off. This is because of the time required to initialize ONTICK. Subsequent readings are more accurate.

Accuracy is increased by stretching readings to every 10 seconds. This is necessary when higher accuracy is needed.

Other factors affecting accurate readings in this program include serial communications and ONITR statement. If ONITR is in process, ONTICK is delayed until ONITR is finished.

The problem with this routine is periodically, a large negative number is returned. This is because the multimode counter has rolled over. This is corrected by periodically resetting the CNTR or transferring PR to CNTR. Refer to the data sheet, *Appendix A* for counter operating modes.

This program sets up the LS7166 to cause an interrupt when a preset number of counts is reached. W8[7-8] is jumpered to interrupt on a borrow.

```

10  LINEB 6,1,132
20  COUNT 0,1000 : REM write to CNTR
30  LINEB 6,1,8 : REM transfer PR to CNTR
40  LINEB 6,1,72 : REM enable A/B counters
50  ONITR 500
100 PRINT COUNT(0) : REM print progress
110 GOTO 100

500 PRINT "In Interrupt"
510 RETI
    
```

Line 10 sets OCCR to divide by N. Line 50 enables interrupts. Line 100 prints the counter. When pulses are applied to the A input, the count will go down. When 1000 pulses are detected at A input, the message in line 500 is printed.

COMMANDS

The table below lists commands used with the counter.

Command	Function
COUNT(0)	Returns value in counter
COUNT 0,n	Writes value to counter

DESCRIPTION

There are three power management modes. Each mode affects the way RPBASIC operates. The **IDLE** command is used to control how the card operates

Default mode is full power. All commands, timers, and interrupts function. **IDLE** command is not used.

There are a number of ways to exit the **IDLE** mode in conjunction with ONITR. Refer to *Chapter 12, External Interrupt* and *Chapter 13, Multi-mode Counter* for ways to generate interrupts. **IDLE 2** is restricted on the type of interrupt. The signal at P2-INT must return to a high state before the next **IDLE 2** command is executed. (P2-INT is also controlled by the multi-mode counter and optically isolated interrupt, described in Chapter 12 and 13.) If it does not go high, **IDLE 2** mode will exit in approximately 3 ms. This is due to a characteristic of the A6 mask revision in the Dallas 80C320 CPU. A general rule is to keep the negative pulse at P2-INT greater than 50 ns but less than 3 ms.

IDLE or **IDLE 0** waits until an ONTICK or ONITR interrupt occurs. Serial I/O operates normally. Use this command when you want your program to "hang out" until something happens. The RPC-320 operates under full power.

IDLE 1 reduces power by 30%. Here the CPU "shuts down" but the internal timers are still operating. ONTICK and ONITR will cause the card to come out of power down mode. However, the RS-232 serial ports are disabled. Characters in the transmitter buffer are not sent out and incoming characters are ignored.

IDLE 2 is the lowest power mode. The CPU, internal timers, serial ports, and oscillator are turned off. Only interrupts responding to ONITR wake up the processor. Current consumption is less than 5 ma with no signals going into or coming from the RPC-320.

IDLE 2 also has a number of operating restrictions. This mode shuts down the RS-232 receiver/driver IC, so no characters can come in or go out. This IC also supplies current for the amplifiers and analog to digital converter. Do not apply negative voltages to the analog input in this mode. The tick timer is shut off. However, the real time clock module, if installed, continues to operate.

NOTE: The RS-232 receiver is shut down in IDLE modes 1 and 2. Any characters sent to the RPC-320 during this time are ignored or

grossly distorted.

NOTE: Delay printing out the RS-232 ports for at least 20 ms (20 instructions) after exiting IDLE 1 or IDLE 2. These chips generate RS-232 voltages and require a "power up" time. Failure to do so could result in garbled characters.

NOTE: The < Ctl> -C break character is not recognized in **any** of the IDLE modes. Normally this is not a problem except during program development. If the program is executing an IDLE statement and it won't respond to any interrupts, pressing the reset button is the only way to exit.

Exit **IDLE 2** by applying a low going pulse at the INT input at P2. The pulse width should be 50 ns minimum. The other **IDLE** modes require a pulse width of at least 1 micro-second. Optical interrupt ISOA/B may also be used to exit any of the **IDLE** modes. The pulse width needs to be at least 10 micro-seconds.

FURTHER POWER REDUCTION

Some applications require the least amount of power possible. You may remove certain IC's from the card to do this. The table below lists the IC 'U' number, approximate current consumption (in shutdown and run mode), and function.

Un	Current		Function
	Run	Shutdown	
U9	10 mA	400 uA	RS-485 interface
U14	100 uA	1.2 ma	Reference for U 15, temperature reference.
U15	5 ma	10 uA	Analog to digital converter
U11	10 mA	1 ua	Digital I/O at J3
U17	10 mA	1 ua	Display output, keypad scanner.
U8	30 mA	10 uA	RS-232 driver/receiver, power supply for analog to digital converter, amplifiers

Currents are maximum and minimum as specified by the manufacturer. Min-max current ranges "guaranteed" by the device manufacturer have a tremendous range, often by a factor of 10 or more. Current above is "typical".

Some current consumption is difficult to determine. Digital outputs, for example, will draw virtually no current under no load conditions, but can supply 15 ma to each output if required. Therefore, inputs and outputs connected to the card will affect its current consumption. Some chips, such as U9, will not draw much current unless there is activity on the RS-485 port.

Board current consumption may be affected by the setting of jumper W7. This jumper determines if inputs at J3 are pulled up or down. When set to pull up inputs, each line forced low increases current consumption by 50 uA. If all inputs are tied to + 5V or ground, removing jumper W7 may draw less current.

The application program IC in U6 may be changed to a 29C040. This 512K byte memory draws 200 uA *less* current than a 32K byte one.

Any control line from P2 to ground draws 500 uA due to the 10K pull-ups. Lines at P6 are pulled to + 5V through a 10K resistor. Each low line draws 500 uA.

The contrast adjustment (R18) can be removed or adjusted for minimum current.

Program Example

This example makes the RPC-320 go into its lowest power mode.

```
10 ONITR 500
   .
   .           other code
   .
100 IDLE 2
200 GOTO 100
500 PRINT "In interrupt"
510 RETI
```

ELECTRICAL SPECIFICATIONS

CPU

80C320, 22.1184 Mhz clock

Memory

RPBASIC-52, 32K ROM, jumperable for 64K.

Type: 27C256 Access time: 80 ns or faster.

Programming and data is 32K or 128K RAM standard, 512K Optional.

RAM optionally battery backed up. Battery life is 5-10 years depending upon RAM size, type, and operating temperature and time.

Maximum BASIC program is 62K

Battery backed using DS1216DM, which also acts as a real time clock. Can also use DS1213C or D to battery back ram.

Digital I/O

The RPC-320 has 34 digital I/O lines. 24 are from J3, which is a general purpose port.

The specifications below are for digital I/O at P6 and J3 except for the eight high current lines at J3.

Drive current	2.5 ma maximum per line, sink or source. TTL compatible.
Output low voltage	0.45V max at 2.5 mA, 1V max at 15 mA for opto rack.
Output high volts	2.4V minimum, sink or source at rated current.

All digital input lines are TTL compatible.

High current output at J3

8 of the 24 lines can drive up to 500 ma at 50V. Refer to *CHAPTER 6, DIGITAL AND OPTO PORTS* for limitations.

High current output at L8

L8 sinks up to 2 amperes at 50 Volts. Switching is through a "zero" ohm FET switch.

Opto isolated input ISOA/ISOB

Isolated voltages to 250 volts peak may be applied to this input. A series resistor is necessary for voltages above 12V.

Keypad input

10 lines accept a 16 position matrix keypad. Scanning and debounce performed in RPBASIC-52.

Display output

14 digital and 6 power and ground lines used to control LCD, VF, and LCD graphics displays. Displays supported in RPBASIC-52.

Serial ports

Two RS-232D serial ports. All have RxD, TxD, and CTS lines. COM0 has only these lines. COM1 also has RTS. COM1 configurable to RS-232 or RS-422/485. Termination network for RS-422/485 available. Baud rates from 300 to 38.4K are program mable. Length fixed at 8 bits, no parity, 1 start and stop bit.

EPROM and programmer

Accepts 29C256, 29C010, 29C040 or equivalent flash EPROM from Atmel.

Size: 32K (29C256), 128K(29C010), 512K(29C040)

Calendar/Clock

Optional DS-1216DM installed in socket U5.

Accuracy to 1 minute/month

Supported by RPBASIC

Expected life 3 to 5 years depending upon RAM size installed, temperature, and operating time.

Watchdog timer, reset

Watch dog timer resets CPU when enabled.

Time between resets is 380 ms or 2.8 seconds

Push button reset. External reset through W10.

Power requirements

+ 5 ±5% at 95 ma operating.

Current consumption is less than 5 ma in IDLE 2 mode, all components installed.

Current is less than 1 ma when analog and RS-485 chips (U14, 15,16, and 9) are removed.

RS-232 voltages generated on card.

Current consumption does not include any opto-modules or other accessories.

MEMORY AND I/O BANK MAP

Memory

Description	Address
RPBASIC-52, U4	0000H - 7FFFH
RAM, U5, 32K	00000H - 07FFFH
128K	00000H - 1FFFFH
512K	00000H - 7FFFFH

I/O Bank

RAM (U5)	0
EPROM (U6)	1
not used	2
Digital I/O (U11)(J3)	3
Display & keypad (U17)	4
Control & L0-L8 (U19)	5
Counter (U13)	6
not used	7

MECHANICAL SPECIFICATIONS

Size

4.6" x 7.0"

4 mounting holes are 0.250 x 0.250 inches from each edge. Mounting holes are 0.124 inch in diameter.

Board thickness: 0.062

Board material: FR-4

JUMPER DESCRIPTIONS

A * after a jumper position indicates factory default is jumpered.

Jumper	Description
W1[1-2]*	RAM size 32K, 128K
W1[2-3]	RAM size 128K
W3[1-3],[2-4]	29C040 Flash
W3[3-5],[2-4]	29C010 Flash
W3[3-5],[4-6]	29C256 Flash
W2[1-3],[2-4]	EPROM selected
W2[3-5],[4-6]*	Flash EPROM selected
W4[1-2]	COM1 RS-485 input
W4[2-3]*	COM1 RS-232 input
W5[1-2]*	RS-485 terminator
W6[1-2]*	RS-485 terminator
W7[1-2]*	J3 resistors pulled up
W7[2-3]	J3 resistors pulled down
W8[1-2]	External or isolated interrupt
W8[3-4]	Counter carry or borrow interrupt
W8[5-6]	Counter carry interrupt
W8[7-8]	Counter borrow interrupt
W9[1-2]*	Do not autorun
W9[no jumper]	Autorun on reset
W10[1-2]	External reset input.